

- 1 A network administrator has captured a data frame in the network with the destination MAC address of 01-00-5E-A0-B1-C3. The correct statement about this MAC address is Q.
- A. It is a unicast MAC address
 - B. It is a broadcast MAC address
 - C. It is a multicast MAC address (Right Answers)
 - D. It is an illegal MAC address

2. Which of the following is not the working principle of CSMA/CD?

- A. Listen While Talk
- B. Retransmission after a fixed time delay (Right Answers)
- C. Conflict suspension
- D. Retransmission after random delay
- E. Listen Before Talk

Answer: B

3. The IPv4 address of the host is 200.200.200.201/30. Which host with the following IPv4 address and its communication do not need to be forwarded by the router?
- A. 200.200.200.1
 - B. 200.200.200.202 (Right Answers)
 - C. 200.200.200.200
 - D. 200.200.200.203

Answer: B

4. If the Ethernet data frame is Length/type=0x0806, which of the following statement is correct? (Multiple Choice)

- A. This data frame is an Ethernet II frame. (Right Answers)
- B. This data frame is an IEEE 802.3 frame
- C. The source MAC address of this data frame must not be FFFF-FFFF-FFFF (Right Answers)
- D. The destination MAC address of this data frame must be FFFF-FFFF-FFFF.

Answer: AC

5. When a router enabled with Proxy ARP function receives an ARP request packet and finds that the requested IP address is not its own, what actions are performed? (Multiple Choice)
- A. If there is a route to the destination address, send its own MAC address to the ARP requester (Right Answers)
 - B. Discard the message
 - C. Broadcast ARP request message
 - D. Find if there is a route to the destination address or not (Right Answers)

Answer: AD

6. Which of the following storage media are commonly used by Huawei routers? (Multiple Choice)

- A. SDRAM (Right Answers)
- B. NVRAM (Right Answers)
- C. Flash (Right Answers)
- D. Hard Disk
- E. SD Card (Right Answers)

Answer: ABCE

7. The Vag operating system commands are divided into four access levels. Which level can run various business configuration commands but cannot operate the file system?
- A. Access level
 - B. Maintenance level
 - C. Development level (Right Answers)
 - D. Management level

Answer: C

8 On the VRP interface, you cannot use the command delete or unreserved vrpcfg zip to delete files. You must empty them in the recycle bin to delete files completely.
 OA. TRUE
 OB FALSE (Right Answers)

Answer: F

9 The switch MAC address table is existing as follows. which of the following statements is correct?

(fluawei>ictim mac-address
 RAC address table of slot 0:

*AC Address	VLAN/ VSI/SI	PtVLAN CEVLAN	Port	Type	(17R llk7.1tn1-!
SON -0811 0b49 I			Eth0/0/3	static	

Total amount of items on slot 0 displayed =

*AC address table of slot C:

*AC Akira:	VLAN/ VSI/SI	PEVLM Cf YLMI	Port	Type	LSP/LSR-ID RAC-Tunnel
5489-989d-1d30			Eth0/0/1	*static	0/-
5485-9895-18a6 I			Eth0/0/2	dynamic	0/-

total watching item on slot 0 displayed = 7

- E A The MAC address 5489-9885-1838 is manually configured by the administrator.
- E 13_ The MAC address 5489-9811-0b49 is manually configured by the administrator (Right Answers)
- E C. The MAC address 5489-3891-1450 is manually configured by the administrator.
- E D. After the switch is restarted, all MAC addresses need to be re-learned.

Answer: 13

10 As shown in the figure below, the switch starts the STP protocol. When the network is stable, which of the following statements are correct? (Multiple Choice)



- A SWB is the root bridge in this network
- B SWA is the root bridge in this network (Right Answers)
- C Both ports of SWB are in Forwarding state (Right Answers)
- D Both ports of SWC are in Forwarding state_

Answer: BC

11 The STP protocol is enabled on both switches shown in the figure below_ An engineer made the following conclusions on this network_ Do you think what is the correct conclusion? (Multiple Choice)

- A The G0/0/2 port of SWB is stable in the Forwarding state (Right Answers)
- B The G0/0/2 port of SWA is stable in the Forwarding state (Right Answers)
- C Both ports of SWB are designated ports_
- D The G0/0/3 part of SWA is stable in the Forwarding state (Right Answers)
- E Both ports of SWA are designated ports (Right Answers)

Answer: ABDE

12. Compared to STP protocol, which kind of port role is added in RSTP protocol? (Multiple Choice)

A. Alternate port (Right Answers)

B. Backup port (Right Answers)

C. Root port

D. Designated port

Answer: AB

13 As shown in the figure, the two switches use the default parameters to run STP. On Switch A the configuration command STP root primary is used. On the switch B the configuration command STP priority 0 is used. Which of the following ports will be blocked?

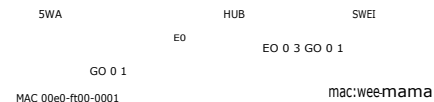

A. G0/0/2 of switch A (Right Answers)

B. G0/0/1 of switch B

C. G0/0/1 of switch A

D. E0/0/3 of HUB

Answer: A

14. Which of the following parameters does not the configuration BPDU packet of the STP protocol?

A. Port ID

B. Bridge ID

C. VLAN ID (Right Answers)

D. Root ID

Answer: C

15. By default, how many seconds are the Forward Delay of STP protocol?

A. 20

B. 15 (Right Answers)

C. 10

D. 5

Answer: B

16. Which of the following parameters are used in the switched network that runs the STP protocol when performing spanning tree calculations? (Multiple Choice)

A. Root path cost (Right Answers)

B. Port ID (Right Answers)

C. Bridge ID (Right Answers)

D. Forward Delay

Answer: ABC

17. In the STP protocol, assume that all switches are configured with the same priority. The MAC address of switch 1 is 00-e0-fc-0600-40, and the MAC address of switch 2 is 011.04.00-00-10, the MAC address of switch 3 is e.00-e0-fc-00-00-20, and the MAC address of switch 4 is 00-e0-fc-00-00-80, then the root switch should be ()

A. Switch 1

B. Switch 2 (Right Answers)

C. Switch 3

D. Switch 4

Answer: B

18. The network shown in the figure below, the MAC address of the switch has been marked Enter the command sip root secondary on the SW0 switch. Which of the following switches become the root bridge of this network

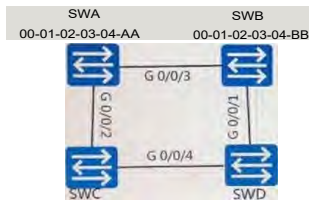

- A SWA
- B SWB
- C SWC
- D SWD (Right Answers)

Answer: D

19. Both the two switches shown in the following figure have STP enabled. Which port will eventually be in the Blocking state?

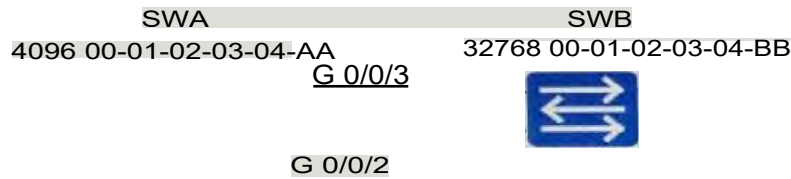

- A. G0/0/2 port of SWA
- B. G0/0/3 port of SWA
- C. G0/0/2 port of SWB
- D. G0/0/3 port of SWB (Right Answers)

Answer: D

20. The network as shown in the following figure, after the OSPF protocol is stable, what is the neighbor status of Router A and Router B?

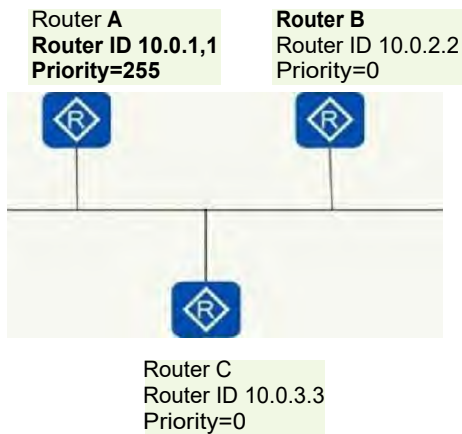

- A. 2-way
- B. Down
- C. Full (Right Answers)
- D. Attempt

Answer: C

21. In the network shown below, which of the following commands can be entered in the router to enable Host A to ping through Host B? (Multiple Choice)



- A. Router A : ip route-static 10.0.12.5 255.255.255.252 11.0.12.1 Router B : ip route-static 10.0.12.1 255.255.255.252 11.0.12.2
- B. Router A : ip route-static 0.0.0.0 0.0.0 11.0.12.1 Router B : ip route-static 0.0.0.0 0.0.0 11.0.12.2
- C. Router A : ip route-static 10.0.12.5 255.255.255.252 11.0.12.2 Router B : ip route-static 10.0.12.1 255.255.255.252 11.0.12.1 (Right Answers)
- D. Router A : ip route-static 0.0.0.0 0.0.0 11.0.12.2 Router B : ip route-static 0.0.0.0 0.0.0 11.0.12.1 (Right Answers)

Answer: CD

22. The network as shown in the following figure, the following configurations exist on the Router A. Which of the following statements are correct? (Multiple Choice)
 ip route-static 10.0.2.2 255.255.255.255 10.0.12.2
 ip route-static 10.0.2.2 255.255.255.255 10.0.21.2 preference 70

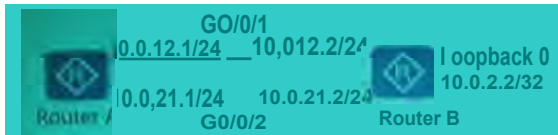

- A. The NextHop that reaches 10.0.2.2 in the routing table of Router A is 10.0.12.2. (Right Answers)
- B. If the G0/0/1 port is Down, the route that Router A reaches 10.0.0.2 is changed to 10.0.21.2. (Right Answers)
- C. The NextHop that reaches 10.0.2.2 in the routing table of Router A is 10.0.21.2.
- D. If the G0/0/2 port is Down, the route that Router A reaches 10.0.0.2 is changed to 10.0.12.2.

Answer. AB

23. Which of the following OSPF versions are suitable for IPv6?

- A. OSPFv2
- B. OSPFv3 (Right Answers)
- C. OSPFv4
- D. OSPFv1

Answer: B

24 The network as shown in the following figure, which of the following commands can enable RouterA to forward a packet with the destination IP address of 19 00 32 (Multiple Choice)

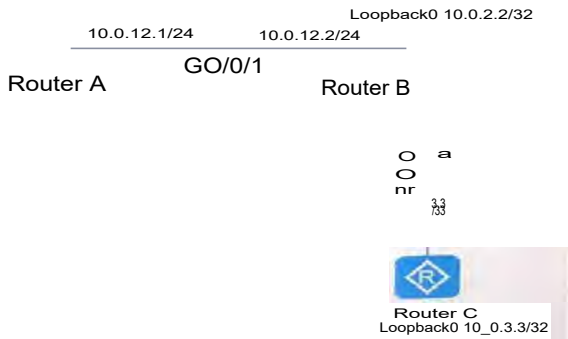

- A ip route-static 10.0.3.3 255 255 255 255 10.0.122 (Right Answers)
- B ip route-static 10.0.2.2 255 255 255 255 100.12.2 ip route-static 10.0.3.3 255 255 255 255 10.0.2.2 (Right Answers)
- C ip route-static 0.0.0.0 0.0.0.0 10.0.122 (Right Answers)
- D ip route-static 10.0.33.255 255 255 255 1002.2

Answer: ABC

25. Which of the following about the statement of static routing are incorrect?

- A. Manual configuration by network administrator
- B. Inter-route information needs to be exchanged between routers (Right Answers)
- C. Can not automatically adapt to changes in network topology
- D. Low system performance requirements

Answer: B

26. Which of the following commands can be used to check whether OSPF has correctly established neighbor relationships?

- A. display ospf neighbor
- B. display ospf brief
- C. display ospf peer (Right Answers)
- D. display ospf interface

Answer: C

27 For multiple paths to the same destination network, the router needs to select by comparing the size of the Cost value. If the value of the Cost is the same, then select according to the size of the Preference value.

- A. True
- B. False (Right Answers)

Answer: B

28. As shown in the figure below, Host A and Host B cannot communicate.



HOST A

HOST B

IP: 10.0.12.1/30

MAC: MAC-A

IP: 10.0.12.2/24

MAC: MAC-B

- A. True (Right Answers)
- B. False

Answer: A

29 For multiple paths to the same destination network, the router needs to select by comparing the size of the Preference value. If the Preference is the same, then select according to the size of the Cost value.

- A. True (Right Answers)
- B. False

Answer: A

30. The routing table consists of multiple elements. What is wrong with the following statement?

```
>show ip routing-table
Route Flag: R - relay, D - Download to fib

Routing Table: Public
  Destinations : 9      Routes : 4

Destination/Mask    Proto    Pre  Cost    Flags NextHop         Interface
-----
```

- k Proto shows to learn the routing protocol of this route
- B. NextHop shows the local interface address of this route (Right Answers)
- G. Pre shows the priority of this routing protocol
- D. Destination/Mask shows the address and mask length of the destination network/host

Answer: B

31 The correct description of the following is 0 (Multiple Choice)

- A. The next hop in the routing table is redundant. If there is an outgoing interface, the packet can be forwarded.
- B. Routes obtained through different routing protocols have different priorities (Right Answers)
- C. The metrics defined by different routing protocols are not comparable (Right Answers)
- D. The metrics defined by different routing protocols are comparable

Answer: BC

32. ip route-static 10_0.2.2 255255/55.25510.0.12.2 preference 20, about this command, which is the correct statement? (Multiple Choice)
- A. The route can guide the data packets forwarding with the destination IP address of 10.0.2.2. (Right Answers)
 - B. The route can guide the data packets forwarding with the destination IP address 10.0.12.2.
 - C. The priority of the route is 20 (Right Answers)
 - D The NextHop of the route is 10.0.12.2 (Right Answers)

Answer: ACD

33. The network as shown in the following figure, when the network administrator performs traffic planning, it is expected that the packets sent by Host A to Host B will be connected to G0/0/3 interface between the routers. The packets sent by Host B to Host A go pass the G0/0/4 interface between routers Which of the following commands can implement this requirement ~(Multiple Choice)

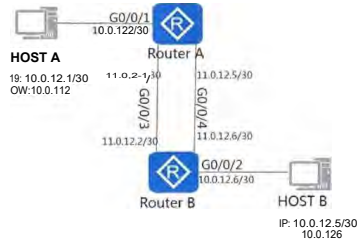

- A. Router A ip route-static 10 0.12.5 255 255 252 11.0.12.2 Router B ip route-static 10.0.12 125525525252 11012.5 (Right Answers)
- B Router A ip route-static 0 0 0 0.0.0.0 11.0.12 6 Router B ip route-static 0 0 0 0.0.0.0 11 0.12.1
- C. Router A ip route-static 10.0.12 5 25525525252 11 0.12_6 Router B ip route-static 10 0 12 1 255 255 252 11 0 12.1
- D. Router A ip route-static 0 0 0 0 0 0 0 11.0 12 2 Router B ip route-static 0.0.0.0 0.0.0.0 11_0.12.5 (Right Answers)

Answer: AD

34. If the IP address requested by the DHCP client is already occupied, which packet will the DHCP server use as the response?
- A. DHCP ACK
 - B DHCP RELEASE
 - G. DHCP NAK (Right Answers)
 - D. DHCP DISCOVER

Answer: C

35. The DHCP REQUEST message must be sent in broadcast form.
- A. True
 - B. False (Right Answers)

Answer: B

36. Which DHCP message does the DHCP client send when it wants to leave the network?
- A. DHCP DISCOVER
 - B. DHCP RELEASE (Right Answers)
 - C. DHCP REQUEST
 - D. DHCP ACK

Answer: B

- 37 Huawei devices can be managed using the Telnet protocol. Which of the following statements is correct about this management function?
- A The port number used by Telnet defaultly is 22, which cannot be modified
 - B. Telnet must enable the VTY interface, and the maximum is 15 (Right Answers)
 - C. Telnet does not support authentication based on username and password
 - D. Telnet does not support deploying ACLs to increase security.

Answer: B

38 As shown, the topology and the configuration on the switch interconnect pod, you can determine that the data frame labeled as VLAN 10 can be forwarded normally between the two switches.

```

GEO 1
GE 1
LSW1
LSW2
[LSW1]interface GigabitEthernet0/0/1
[LSW1-GigabitEthernet0/0/1]Port link-type trunk
[LSW1-GigabitEthernet0/0/1]Port trunk pvid vlan 20
[LSW1-GigabitEthernet0/0/1]Port trunk allow-pass vlan 10
[LSW2]interface GigabitEthernet0/0/1
[LSW2-GigabitEthernet0/0/1]Port link-type trunk
[LSW2-GigabitEthernet0/0/1]Port trunk pvid vlan 10
[LSW2-GigabitEthernet0/0/1]Port trunk allow-pass vlan 10
 A True
 B- False (Right Answers)

```

Answer: B

30 The output information of a port of the switch is as follows What is wrong with the following statement?

```

interface GigabitEthernet0/0/1
port link-type trunk
port trunk pvid vlan 100
port trunk allow-pass vlan 100 200

```

- A. If the data frame carries a VLAN TAG of 200, the switch strips the VLAN TAG and sends out (Right Answers)
- B. If the port receives a data frame without VLAN TAG, the switch needs to add VLAN TAG100.
- C The link type of the port is Hybrid type
- D. If the data frame carries a VLAN TAG of 100, the switch strips the VLAN TAG and sends out

Answer: A

40 Which information of the data frame is judged by the VLANIF interface to perform Layer 2 forwarding or Layer 3 forwarding?

- A. Destination MAC (Right Answers)
- B Source IP
- C. Destination port
- D Source MAC

Answer: A

41 Packets forwarded between two routers must not carry VLAN TAG.

- A True
- B False (Right Answers)

Answer: B

42. The Priority field in the VLAN tag identifies the priority of the data frame. What is the priority range?

- A. 0-15
- B. 0-63
- C. 0-7 (Right Answers)
- D. 0-3

Answer: C

43. What is the characteristic of port-based VLAN partition?

- A. Add a VLAN tag to the data frame based on the IP address carried in the packet.
- B. Assign the VLAN ID according to the protocol type and encapsulation format of the data frame.
- G. The host moving location no need to reconfigure the VLAN
- D. The host moving location needs to reconfigure VLAN **(Right Answers)**

Answer: D

44. The Protocol field in the PPP frame format is Ox223, indicating that the protocol is:

- A. CHAP **(Right Answers)**
- B. PAP
- C. NCP
- D. LCP

Answer: A

45 The configuration information of a router is as follows. Which combination of wername and password used by the peer router can enable PPP channel associated to complete authentication?

```
est1@router1> show run
router1> enable Password cipher test
router1> test service -YPC1514
router1> est1 Password cipher test1
router1> est2 Password cipher test2
router1> est3 Password cipher test3
#
router1> est4 10/0
router1> est5 10/0
router1> ppp
router1> ppp authentication mode test
router1> ppp authentication mode test2
```

- A. Username: (esti Password: (esti
- B. Llwname: test Password: test **(Right Answers)**
- C. Username: test2 Password: test
- D. Username: test2 Password: test2

Answer: B

46. Which method does the PPPoE client use to send PADI packets to the Server?

- A. Broadcast **(Right Answers)**
- B. Unicast
- C. Multicast
- D. Anycast

Answer: A

47 The network shown in the following figure requires the network where the host is located to access the Internet through Easy IP. Which of the following ACL5 should be used on the 00/0/3 interface of the muter?

- A. ad number 2000 rub 5 permit source 10 0.13.1 0 0 0 0
- B. act number 2000 rub 5 permit source 10 0.120 00 0255
- G ad number 2000 rub 5 permit source 100 12_1 00 00
- B. act number 2000 rub 5 permit source 100_13 0 0 0 0255 **(Right Answers)**

Answer: 0

48 The configuration information of a router is as follows Which of the following statement is correct? (Multiple Choice)

ISOM

```
authent i cal ien..schtme default
authentication-scheme huawei
  authentication-mode radius
authorization-scheme default
authorisation-scheme huawei
accounting-scheme*, default
domain default
domain default_admin
domain huawei
  authentication-schema huawei
  authorization-scheme huawei
local-user huawei password cipher 1.23956
local-user huaweitthuawei password cipher GS41321.
```

ke

- A. The domain which domain name is huawei does not use the accounting scheme. (Right Answers)
- B. If the username huawei is used for authentication, the password needs to be 654321.
- C. The authorization mode used by the domain which domain name is huawei is local authorization. (Right Answers)
- D. The authentication mode used by the domain which domain name is huawei is local authentication.

Answer: AC

49. The IKE protocol is used to establish an SA for IPsec auto-negotiation, which can support identity authentication when the address of the initiator of the negotiation changes dynamically

- A. True (Right Answers)
- B. False

Answer: A

50. By default, in the SNMP protocol, which port number is used by the proxy process to send an alarm message to the NMS?

- A. 163
- B. 161
- C. 162 (Right Answers)
- D. 164

Answer: C

51. If the result of the packet matching ACL is "reject", the packet is finally discarded.

- A. True
- B. False (Right Answers)

Answer: B

52. In terms of security, IPsec tunnel mode is superior to IPsec transport mode.

- A. True (Right Answers)
- B. False

Answer: A

53. What is the status of the OSPFv3 adjacency relationship after it is established?

- A. Loading
- B. 2-way
- C. Full (Right Answers)
- D. Down

Answer: C

54. The network as shown in the following figure, when OSPFv3 is enabled on all interfaces, Router A and Router B cannot establish adjacencies.

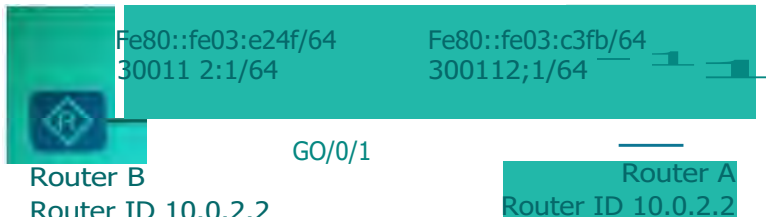

- A. True (Right Answers)
- B. False

Answer: A

55. Which of the following fields are fields that exist in both IPv6 and IPv4 headers? (Multiple Choice)

- A. Source Address (Right Answers)
- B. Version (Right Answers)
- C. Destination Address (Right Answers)
- D. Next Header

Answer: ABC

56. What is the destination address of the DHCPv6 request packet?

- A. FF01::1:2
- B. FF02::1:2 (Right Answers)
- C. FF02::1
- D. FF02::2

Answer: B

57. By default, how many seconds is the period of OSPFv3 HELLO packet sending on the Ethernet link?

- A. 30
- B. 10 (Right Answers)
- C. 20
- D. 40

Answer: B

58. Which of the following fields does the MPLS header include? (Multiple Choice)

- A. Label **(Right Answers)**
- EXP **(Right Answers)**
- TTL **(Right Answers)**
- Tas

Answer: ABC

59 SR (SegmentRouting) defines a destination address prefix/node and adjacency in the network as segments, and assigns SIDS (Segment 10s) to the segments. By performing an unordered list of Adjacency SIDS and Prefix/Node SIDS (destination address prefixes/node segments), a forwarding path is obtained

- A True
- B False **(Right Answers)**

Answer: B

60 The ARP protocol can resolve the MAC address of the target device according to the destination IP address, thereby, to map the link layer address and the IP address

- A True **(Right Answers)**
- B. False

Answer: A

61 The Traced diagnostic tool records the 0 of each ICMP TTL timeout message so that the user can be provided with the IP address of the packet when it arrives at the destination_

- A Destination port
- B. Source port
- C Destination IP address
- D. Source IP address **(Right Answers)**

Answer: D

62. VLSM can expand any IP network segment, including Class D addresses.

- A. True
- B. False **(Right Answers)**

Answer: B

63_ Which fields in the IPv4 header are related to sharding? (Multiple Choice)

- A_ Fragment Offset **(Right Answers)**
- Flags **(Right Answers)**
- G. Tit
- H identification **(Right Answers)**

Answer: ABD

64. The pwd and dir commands in the VRP operating platform can view the file information in the current directory.

- A_ True
- B. False **(Right Answers)**

Answer: 13

65. The output information of a router is as follows. Which of the following statement is correct? (Multiple Choice)

```
<Huawei>display startup
MainBoard:
  Startup system software:      flash:/AR2220E-V200R007COOSPC600.cc
  Next startup system software: flash:/AR2220E-V200R007COOSPC600.cc
  Backup system software for next startup: null
  Startup saved-configuration file: flash:/vrpcfg.zip
  Next startup saved-configuration file: flash:/backup.zip
  Startup license file:        null
  Next startup license file:    null
  Startup patch package:       null
  Next startup patch package:   null
  Startup voice-files:         null
  Next startup voice-files:     null
```

- A. The currently used VRP version file is the same as the VRP file used for the next startup. **(Right Answers)**
- B. The currently used VRP version file is different from the VRP file used for the next startup.
- C. The currently used configuration file is different from the one used for the next startup. **(Right Answers)**
- D. The currently used configuration file is the same as the one used for the next startup.

Answer: AC

66. For a switch running STP, the port can be directly converted to the Disabled state in any state.

- A. True **(Right Answers)**
- B. False

Answer: A

67. Which of the following MAC addresses will not age? (Multiple Choice)

- A. Dynamic MAC address
- B. Black hole MAC address **(Right Answers)**
- C. Static MAC address **(Right Answers)**
- D. Port MAC address

Answer: BC

68. By default, the bridge priority of a switch is 32768.

- A. True **(Right Answers)**
- B. False

Answer: A

69. Which port of the following switches is blocked as shown in the following figure?

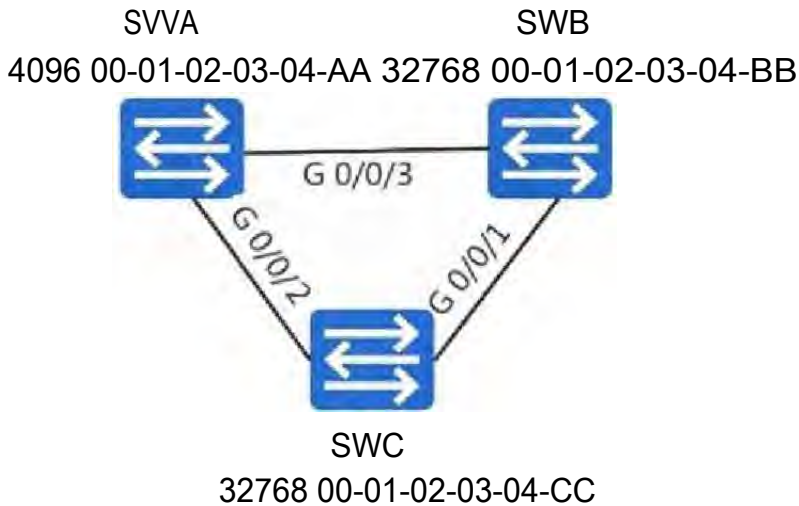

- A. GO/0/2 of SWC
- B. GO/0/1 of SWC (Right Answers)
- C GO/0/3 of SWB
- D. GO/0/3 of SWA

Answer: B

70. As shown in the following figure, all hosts can communicate normally. What is the correct relationship between the SWBMAC address and the port?

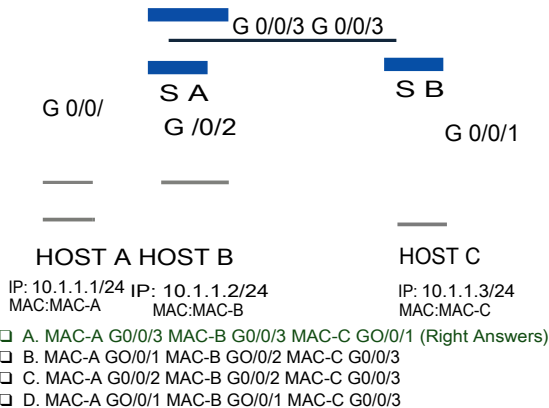

- A. MAC-A G0/0/3 MAC-B G0/0/3 MAC-C G0/0/1 (Right Answers)
- B. MAC-A G0/0/1 MAC-B G0/0/2 MAC-C G0/0/3
- C. MAC-A G0/0/2 MAC-B G0/0/2 MAC-C G0/0/3
- D. MAC-A G0/0/1 MAC-B G0/0/1 MAC-C G0/0/3

Answer: A

71. A switch running STP protocol will send TCN BPDUs only when a port on the switch fails.

- A. True
- B. False (Right Answers)

Answer: B

72. How many bits of the Port ID total length in the spanning tree protocol?
 EI A. 16 (Right Answers)
 EI B. 4
 EI C. 2
 EI D 8

Answer: A

73. As shown in the figure, the correct description about this network topology is 0.

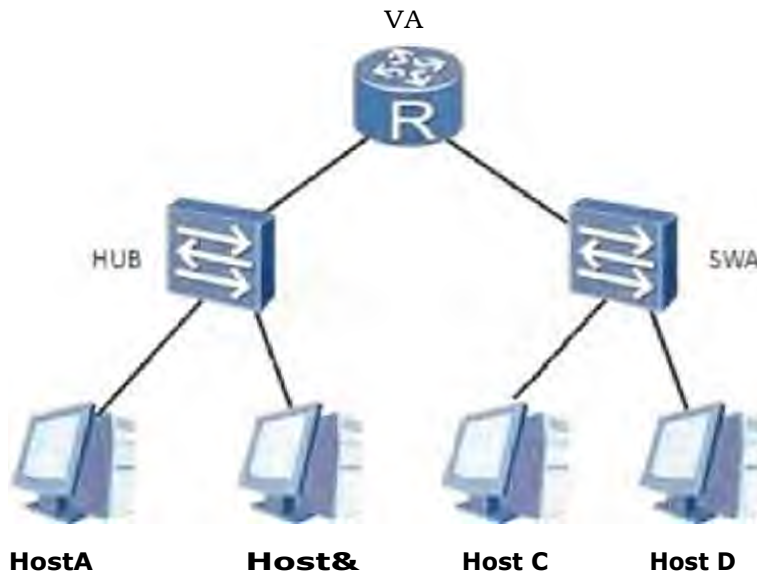

- A. There are 6 collision domains in this network.
 111 B. There are 6 broadcast domains in this network.
 C. There are 12 collision domains in this network.
 EI D. There are 2 broadcast domains in this network. (Right Answers)

Answer: D

74. Which of the following statements about the Backup port in the RSTP protocol is correct?
 A. Backup port as a backup of the designated port, providing another backup path from the root bridge to the corresponding network segment (Right Answers)
 B. Backup port not only forwards user traffic but also learns MAC address
 C. Backup port does not forward user traffic but learns MAC address
 D. Backup port provides another switchable path from the designated bridge to the root as the backup port of the root port

Answer: A

75. A network consisting of switches does not have STP enabled. A Layer 2 loop must occur.
 A. True
 B. False (Right Answers)

Answer: B

76_ When a port running the standard STP protocol receives a suboptimal BPDU, it immediately sends its own configuration BPDU from this port_

- A. True (Right Answers)
- B. False

Answer: A

77 As shown in the following figure, all routers run OSPF protocol_ The top of the link is the size of the Cost value_ What is the path of the RA to the network 10 0 0 NB'?

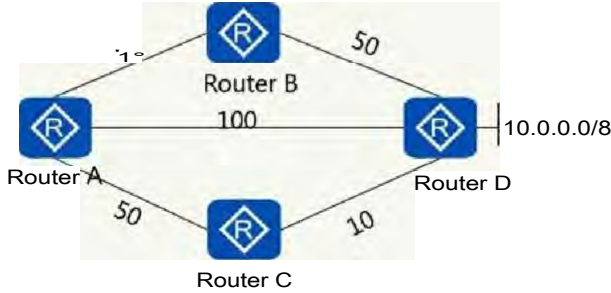

- A. A-B-D
- B. PA can not reach 10.0.0.0.18
- C A-D
- D A-C-D (Right Answers)

Answer: D

78 Which of the following statements about OSPF neighbor status is correct? (Multiple Choice)

- A. In the Exchange state, the routers send each other a DO packet containing the summary of the link state information to describe the content of the local LSDB (Right Answers)
- B. The master-slave relationship of OSPF is formed in the ExStart state (Right Answers)
- C_ After the router LSDB is synchronized, it is converted to the Full state_ (Right Answers)
- D_ The serial number of the OD packet is determined in the Exchange state_

Answer: ABC

79. On the network shown in the following figure, the administrator wants Router A to use static routes to send packets to Router B priority through GO/0/1 Which command can be used to meet this requirement?

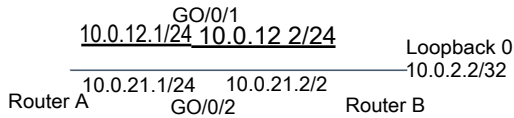

- A. ip route-static 100 22 255.255.255.255 10.0.12.2 ip route-static 10.0.22 255.255.255.255 10.0.212 preference 40
- B. ip route-static 10.0.2.2 255.255.255.255 10.0.122 ip route-static 10.0.2.2 255.255.255.255 10.0.212 preference 70 (Right Answers)
- C ip route-static 10 0 22 255.255.255.255 100_12.2 ip route-static 10 0 22 255.255.255.255 10.0.212
- D ip route-static 10 0 2 255.255.255.255 10.0.12.2 preference 70 ip route-static 10 0 2.2 255.255.255.255 10.0.21.2

Answer: B

80 ip route-static 10 0.12.0 255 255.255 0 192.168.1.1

The correct description about this command is 0.

- A. The priority of this route is 100
- B. This command configures a route to the 192.168.1.1 network_
- C This command configures a route to the 10_0 12 0 network. (Right Answers)
- D. if the router learns the route of the same destination network as this route through other protocols, the router will prefer this route.

Answer: C

81 Network structure and OSPF partition as shown in the figure, except for R1, routers R2, R3 and R4 are ABR routers of OSPF.

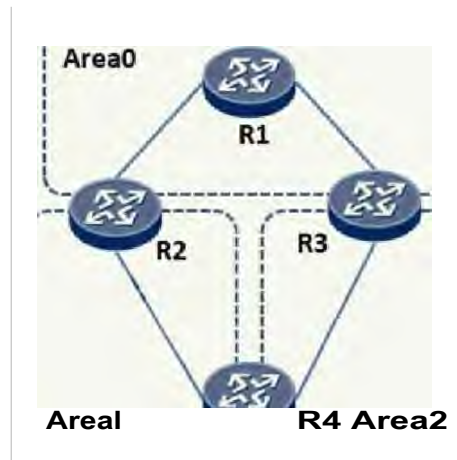

- A True
- B. False (Right Answers)

Answer: B

```
82[R1] ospf
[R1-ospf-1 area 1
[R1-ospf-1-area-00 0 1] netted< 10 0.12 0 0 0 0255
```

As shown in the configuration, the administrator has configured OSPF on R1, but R1 cannot learn the routes of other routers. The possible reason is () (Multiple Choice)

- A This router is not configured with authentication, but the neighbor router is configured with authentication (Right Answers)
- B The OSPF process 10 is not configured when this router is configured.
- C The area ID configured by this router is different from the area ID of its neighbor router (Right Answers)
- B. This router does not announce the network connecting neighbors when configuring OSPF (Right Answers)

Answer: ACID

83. Which of the following data packets is the OSPF protocol encapsulated in?

- A. IP (Right Answers)
- B. liTTP
- C. UDP
- D. TGP

Answer: A

84 Which of the following about the default route is correct! (Multiple Choice)

- A The default route can only be manually configured by the administrator.
- B In the routing table the default route appears as a route to the network 0 0 0 0 (the mask is also 0 0 0 0) (Right Answers)
- C There must be a default route in the routing table of any router
- D If the destination address of the packet cannot match any destination address of the routing table, the packet will be forwarded by selecting the default route (Right Answers)

Answer: BD

85 When configuring a static route on a broadcast interface, you can configure a static route by specifying the next hop address or outbound interface_

- A True
- B False (Right Answers)

Answer: B

86. Which of the following attributes cannot be used as a parameter to measure Cost?

A. Delay

B. sysname (Right Answers)

C. Hop count

D. Bandwidth

Answer: B

87. As shown in the following figure, Router A and Router B establish an OSPF neighbor relationship. The OSPF process ID of Router A is 1 and the area ID is 0. Which of the following methods can enable Router B to obtain the route of the network segment where Host A is located? (Multiple Choice)

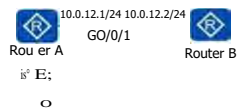

A. ospf area 0.0.0.0 network 192.168.1.0.0.0.255 0 (Right Answers)

B. ospf 1 import-route direct 0 (Right Answers)

C. ospf 1 area 0.0.0.0 network 192.168.0.0.0.255 255 (Right Answers)

D. ospf 1 area 0.0.0.0 network 192.168.1.2 0.0.0.0 0 (Right Answers)

Answer: ABCD

88. Which of the following fields does not contain in HELLO packets of OSPF protocol?

A. Neighbor

B. sysname (Right Answers)

C. Hello Interval

D. Network Mask

Answer: B

89. What are the roles of OSPF DR and BDR? (Multiple Choice)

A. Reduce the number of adjacencies (Right Answers)

B. Reduce the type of OSPF packets

C. Reduce the time it takes to establish adjacency

D. Reduce the number of exchanges of link state information (Right Answers)

Answer: AD

90. Which of the following are routing protocols? (Multiple Choice)

A. BGP (Right Answers)

B. IPX

C. OSPF (Right Answers)

D. IP

Answer: AC

91. A company network administrator wants to be able to remotely manage branch network devices. Which of the following protocols will be used?

- A. VLSM
- B. Telnet (Right Answers)
- C. RSTP
- D. CIDR

Answer: B

92. Which of the following message types does DHCP contain? (Multiple Choice)

- A. DHCP ROLLOVER
- B. DHCP DISCOVER (Right Answers)
- C. DHCP REQUEST (Right Answers)
- D. DHCP OFFER (Right Answers)

Answer: BCD

93. Telnet is based on the TCP protocol.

- A. True (Right Answers)
- B. False

Answer: A

95. What should do when the Access port sends a data frame?

- A. Replace VLAN TAG forwarding
- B. Stripping TAG forwarding (Right Answers)
- C. Mark PVID forwarding
- D. Send a message with TAG

Answer: B

96. If the configuration information of a port on a switch is as follows, when this port sent the data frames of which VLAN, the VLAN TAG is stripped?

```
interface GigabitEthernet0/0/1
port hybrid tagged vlan 2 to 3 100
port hybrid untagged vlan 4 6
```

- A. 4,5,6
- B. 4,6
- C. 1,4,6 (Right Answers)
- D. 1,4,5,6

Answer: C

97. The configuration information of a port on the switch is as follows, when the port sends the data frame of which VLAN TAG is carried, the VLAN TAG is stripped?

*

```
interface GigabitEthernet0/0/1
port link-type trunk
port trunk pvid vlan 10
port trunk allow-pass vlan 10 20 30 90
```

- A 10 (Right Answers)
- B 20
- C. 30
- D. 40

Answer: A

98. When a port of the switch sends a data frame carrying the same VLAN TAG and PVID, it must strip the VLAN TAG forwarding.

- A. True
- B FaEse (Right Answers)

Answer: B

99 As shown in the following figure, Router A uses manual link aggregation and adds G0/0/1 and G0/0/2 ports to aggregation group 1 The incorret statement about the status of Router A aggregation port 1 is:

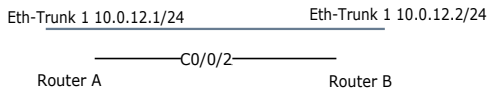

- A_ Only shut down G0/0/2 of Router B, Eth-Trunk 1 protocol up
- Turn off G0/0/1 and G0/0/2 ports on Router B at the same time, Eth-Tmkn 1 protocol up (Right Answers)
- Only shut down G0/0/1 of Router B, Eth-Trunk 1 protocol up
- B. Turn off G0/0/1 and G0/0/2 ports on Router B at the same time, Eth-Trunk 1 protocol down

Answer: B

100. In the network shown in the figure the correct description of the following is:

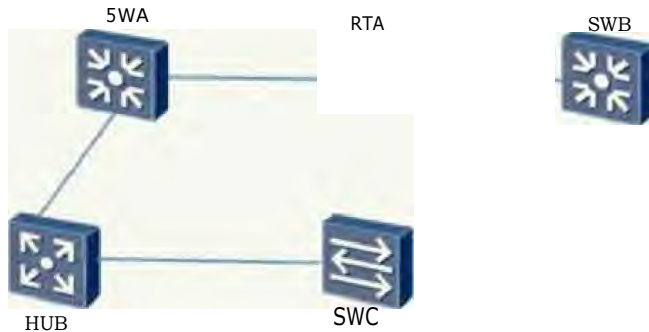

- A. The network between RTA and SWC is the same collision domain.
- B. The network between SWA and SWC is the same broadcast domain. (Right Answers)
- C. The network between SWA and SWC is the same collision domain. (Right Answers)
- D. The network between SWA and SWB is the same broadcast domain.

Answer: BC

109. When NAT uses a dynamic address pool, addresses in the address pool can be reused, that is, the same IP is mapped to multiple intranet (Ps at the same time

- A True
- 11 False (Right Answers)

Answer: B

102. Which of the following values is used in the LengthType field of the Ethernet data frame, indicating that the packet is in the PPPoE discovery phase?

- A. 0x0800
- B. 0x8863 (Right Answers)
- C. 0x8864
- D. 0x0806

Answer, B

103. Regarding PPP configuration and deployment, which of the following statement is correct?

- A. PPP does not support mutual authentication
- B. PPP cannot modify keepalive time
- C. PPP cannot be used to deliver IP addresses.
- D. PPP supports CHAP and PAP authentication modes. (Right Answers)

Answer: D

104. On the Huawei device, if AAA authentication is used for authorization, when the remote server does not respond, authorization can be performed from the network device side.

- A. True (Right Answers)
- B. False

Answer: A

105. As shown in the network, the configuration information of Router A is as follows. Which of the following statement is wrong?

```
acl number 2000
rule 5 deny source 200.0.12.0 0.0.0.7
rule 10 permit source 200.0.12.0 0.0.0.15
```

```
interface GigabitEthernet0/0/1
traffic-filter outbound acl 2000
```



- A. The host with the source IP address of 200.0.12.2 cannot access the Internet.
- B. The host with the source IP address of 200.0.12.6 cannot access the Internet.
- C. The host with the source IP address of 200.0.12.8 cannot access the Internet. (Right Answers)
- D. The host with the source IP address of 200.0.12.4 cannot access the Internet.

Answer: C

106. Based on ACL rules, which of the following types can an ACL be classified into? (Multiple Choice)

- A. Layer 2 ACL (Right Answers)
- B. User ACL
- C. Advanced ACL (Right Answers)
- D. Basic ACL (Right Answers)

Answer: ACD

107. The Management Information Base MIB is a virtual database that is stored on the NMS.

- A. True
- B. False **(Right Answers)**

Answer: B

108. As shown in the following figure, what is the scope of AH protocol authentication in IPsec tunnel mode?

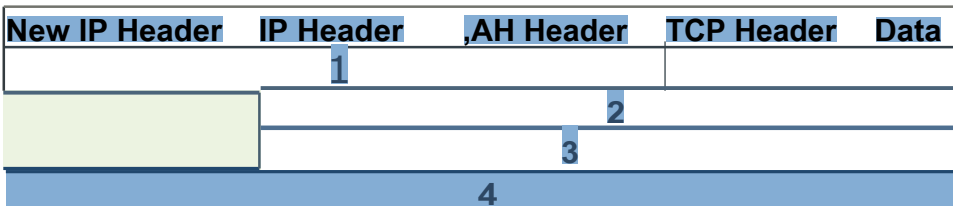

- A. 1
- B. 2
- C. 3
- D. 4 **(Right Answers)**

Answer: D

109. The ACL on the AR G3 series router supports two matching sequences: configuration order and automatic sorting.

- A. True **(Right Answers)**
- B. False

Answer: A

110. The requested node multicast address consists of the prefix FF02::1:FF00:0/104 and the last 24 bits of the unicast address.

- A. True **(Right Answers)**
- B. False

Answer: A

111. How many seconds is the period of the OSPFv3 HELLO packet on the P2P link by default?

- A. 10 **(Right Answers)**
- B. 20
- C. 30
- D. 40

Answer: A

112. The multicast address FF02::2 indicates all routers in the link-local range.

- A. True **(Right Answers)**
- B. False

Answer: A

113. The basic header length of an IPv6 message is a **fixed** value.

- A. True **(Right Answers)**
- B. False

Answer: A

114. IPv6 address 2001: AB EF 22 4E: FFE2: BCC0: CDOO: DDBE 8D58 cannot be abbreviated.

- A. True **(Right Answers)**
- B. False

Answer: A

115. The router Router D neighbor relationship is as follows Which of the following statement is correct? (Multiple Choice)

```
(Router D>display ospfv3 peer 10.0.3.3 verbose
OSPFv3 Process (1)
```

```
Neighbor 10.0.3.3 is 2-Way, interface address FE80::MO:FCFF::4ECS
  In the area 0.0.0.0 via interface GEC/0/0
  DR Priority is 1 DR is 10.0.2.2 BDR is 10.0.1.1
  Options is 01000013
  Dead timer due in 00:00:35
  Neighbour is up for 00:00:00
  Database Suaueary Packets List 0
  Link State Request List 0
  Link State Retransmission List 0
  Neighbour Event: 2
  Neighbour If Id :
```

- A. The router-ID of the DR router is 10.0.2.2. **(Right Answers)**
- B. The router-ID of the DR router is 10.0.1.1.
- C. This router is a DROther router **(Right Answers)**
- D. This router and the router with Router-ID 10.5.3.3 cannot directly exchange link state information. **(Right Answers)**

Answer: ACD

116. SRGB (segment routing global block). A local label set reserved for the global segment. In MPLS and IP_{v6}, SRGB is a collection of local labels reserved for global labels

- A. True
- B. False **(Right Answers)**

Answer: B

117. One of the reasons for the emergence of SR (Segment Routing) is that there are some factors that restrict the development of traditional LOP. What are the correct descriptions about LOP of the following? (Multiple Choice)

- A. LOP calculation depends on IGP. When IGP and LOP are not synchronized, it will cause black holes and affect the service. **(Right Answers)**
- B. LOP itself has 11 kinds of protocol packets, which greatly increases link bandwidth consumption and device CPU utilization. **(Right Answers)**
- C. LOP only supports IGP shortest path (minimum overhead) for path calculation, and does not support traffic engineering. **(Right Answers)**
- D. LOP cannot implement automatic label allocation

Answer: ABC

118. The network administrator wants to be able to effectively use the IP address of the 192.168.176.0/25 network segment. Now the company's marketing department has 20 mainframes, it is best to assign which of the following address segment to the marketing department?

- A. 192.168.176.160/27
- B. 192.168.176.96/27 **(Right Answers)**
- C. 192.168.176.0/25
- D. 192.168.176.4W29

Answer: B

119. When using gm ping command on the VRP platform, do you need to specify an IP address as the source address of the echo request message, which of the following parameters should be used? When using the ping command on the VRP platform, if you need to specify an IP address as the source address of the echo request message, which of the following parameters should be used?

- A. -s
- B. -a **(Right Answers)**
- C. -4
- D. -n

Answer: B

120. Which of the following types of addresses cannot be used as the IPv4 address of host?

- A. Class A address
- B. Class B address
- C. Class C address
- D. Class D address **(Right Answers)**

Answer: D

121. A company applies for a Class C IP address segment, but it is assigned to 6 subsidiaries. The largest subsidiary has 26 computers. Different subsidiaries must be in different network segments. So the network subnet mask of the largest subsidiary should be set to 0.
C A. 255.255.224 (Right Answers)
17 B. 255.255.255.128
C C. 255.255.255.0
E O. 255.255.255.192

Answer, A

122. Which of the following statement about the transport layer protocol is correct? (Multiple Choice)

- A. **UDP** uses the SYN and ACK flags to request to establish a connection and confirm the connection.
- B. Well-known port number range is 0-1023 (Right Answers)
- C. UDP is suitable for transmitting delay-sensitive traffic and can be reorganized according to the sequence number field in the message header.
- D. The establishment of a TCP connection is a three-way handshake process, and the termination of a TCP connection is subject to a four-way handshake. **(Right Answers)**

Answer: BD

123. Which of the following commands can modify the device name to huawei?

- A. rename huawei
- B. sysname huawei **(Right Answers)**
- C. do name huawei
- D. hostname huawei

Answer: B

124. The administrator wants to update the VRP of the AR2200 router. The correct method is (). (Multiple Choice)

- A. The administrator configures the AR2200 as a TFTP server to transmit VRP software through TFTP.
- B. The administrator configures the AR2200 as a TFTP client to transmit VRP software through TFTP. **(Right Answers)**
- C. The administrator configures the AR2200 as an FTP server to transfer VRP software through FTP. **(Right Answers)**
- D. The administrator configures the AR2200 as an FTP client to transfer VRP software through FTP. **(Right Answers)**

Answer: BCD

125. What are the command line views existing on the VRP operating platform?

- A. Interface view **(Right Answers)**
- B. User view **(Right Answers)**
- C. Protocol view **(Right Answers)**
- D. System view **(Right Answers)**

Answer: ABCD

126. Which bridge ID is not possible in the configuration BPDU sent by the switch?

- A. 4096 01-01-02-03-04-05 (Right Answers)
- B. 0 10-01-02-03-04-05
- C. 32768 06_01_02_03_04_05
- D. 0 00-01-02-03-04-05

Answer: A

127. In a switch networking, if a loop occurs, it may cause a broadcast storm.

- A. True (Right Answers)
- B. False

Answer: A

128. The loop protection function provided by the RSTP protocol can take effect only on the specified port.

- A. True (Right Answers)
- B. False

Answer: A

129. In the RSTP protocol, the edge port loses the edge port attribute when it receives the configuration BPDU message.

- A. True (Right Answers)
- B. False

Answer: A

130. When STP is running on Huawei Sx7 series switches, the priority of the switch is 0 by default.

- A. 8192
- B. 32768 (Right Answers)
- C. 16384
- D. 4096

Answer: B

131. Which of the following statement about the role of the STP protocol Forward Delay is correct?

- A. Reduce the time interval for BPDU transmission
- B. Delay in the transition of Blocking state and Disabled state
- C. Improve the convergence speed of STP
- D. Improve the BPDU lifetime and ensure that the configuration BPDU can be forwarded to more switches.
- E. Preventing temporary loops (Right Answers)

Answer: E

132. What is the correct statement about the static MAC address table?

- A. The user is manually configured and delivered to each interface board. The entries cannot be aged. (Right Answers)
- B. By viewing the static MAC address entry, you can determine whether there is data forwarding between the two connected devices.
- C. Static MAC address entries are lost after the system is reset, the interface board is hot swapped, or the interface board is reset.
- D. You can obtain the number of users communicating on the interface by viewing the number of static MAC address entries.

Answer: A

133. Which parameter is used in the spanning tree protocol to erect the root bridge?

- A. Port ID
- B. The system name of the switch
- C. Root path cost
- D. Bridge ID **(Right Answers)**

Answer: D

134 The administrator finds that the two routers stay in the TWO-WAY state when establishing an OSPF neighbor, the correct description of the following is ()

- A. The router is configured with the same zone ID
- B. These two routers are DR Other routers in the broadcast network. **(Right Answers)**
- C. The router is configured with the wrong router ID
- D The router is configured with the same process ID

Answer: B

135 An AR2200 router learns the route entries to the same network through OSPF and RIPv2. The cost of the route learned through OSPF is 4882. The number of hops learned through RIPv2 is 4. The routing table of the router will have ()

- A OSPF and RIPv2 routing
- B 8 OSPF routing **(Right Answers)**
- C Both do not exist
- D RIPv2 routing

Answer: B

136. When the router forwards the datagram, the data link layer needs to be re-encapsulated every time a data link layer is passed.

- A. True **(Right Answers)**
- B. False

Answer: A

137. Which of the following network types does the OSPF protocol support? (Multiple Choice)

- A. Broadcast type **(Right Answers)**
- B. Point to point **(Right Answers)**
- C. Point-to-point type **(Right Answers)**
- D. NBMA **(Right Answers)**

Answer: ABCD

138. Which of the following are the stable states of OSPF neighbor relationships? (Multiple Choice)

- A. Down **(Right Answers)**
- B. Full **(Right Answers)**
- C. 2-way **(Right Answers)**
- D. Attempt

Answer: ABC

139. Which of the following routing protocols are dynamic routing protocols? (Multiple Choice)

- A. OSPF **(Right Answers)**
- B. BGP **(Right Answers)**
- C. Direct
- D. Static

Answer: AB

140 As shown in the figure, all routers run OSPF protocol, and the OSPF process number is 1 and the area number is 0 Which of the following commands can implement this requirement on Router A? (Multiple Choice)

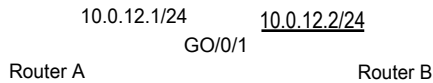

- A # ospf 1 area 00 00 network 10.0.12.1 0 0 00 # (Right Answers)
- B # ospf 1 area 0000 network 100.1200003#
- C # ospf 1 area 0 0 0 network 10 0 12 0 00 0 255 # (Right Answers)
- D # interface GmabitEthernet0/0/1 ip address 10 0 121 255 255 255 0 ospf enable 1 area 0 0 0 # (Right Answers)

Answer: AGO

141. In the OSPF protocol, which of the following description of the DR is correct? (Multiple Choice)

- A. The adjacency relationship must also be established between the DR and the BDR. (Right Answers)
- B. If the priority values of the two routers are equal select the router with the large router ID as the DR (Right Answers)
- C if the priority values of the two routers are different, select the router with the smaller priority value as the DR_
- D By default, all routers in this broadcast network will participate in DR elections (Right Answers)

Answer: ABD

142 As shown in the figure, after the Um routers are configured with OSPF, the administrator configures the <mleninterfaces0f0/1> command on the RTA. The correct description is O (Multiple Choice)

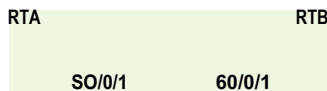

- A The RTA will continue to receive and analyze the OSPF packets sent by the RTB.
- B. The neighbor relationship of the two routers will be down_ (Right Answers)
- C. RTA will not send OSPF packets anymore_ (Right Answers)
- D. The neighbor relationship of the two routers will not be affected

Answer: BC

143. A DHCP OFFER packet can carry a DNS address, but can only carry one DNS address..

- A. True
- B. False (Right Answers)

Answer: B

144 As shown in the following figure, host A logs in to Router A through Telnet, and then obtains the configuration file of Router B through FM on the remote interface_ How many TCP connections exist on Router A?

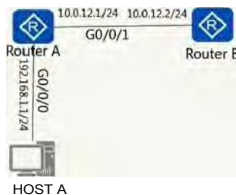

- A. 1
- B. 2
- C. 3 (Right Answers)
- D. 4

Answer: C

145 At present, the company has a network administrator. The AR2200 in the company network can be for remote management after directly enter the password through Telnet.

The company has two new network administrators, and wants to assign all administrators their respective usernames and passwords, as well as different permission levels. So what should do (Multiple Choice)

- A When configuring each administrator's account, you need to configure different permission levels_ (Right Answers)
- B User authentication mode configured by Telnet must select AAA mode (Right Answers)
- C Configure three user names and their corresponding passwords in the AAA New. (Right Answers)
- D Each administrator uses different public IP addresses of the device when running the Telnet command_

Answer: ABC

146. What is the role of the port trunk allow-pass vlan all command?

- A. The connected peer device can dynamically determine which VLAN IDs can pass.
- B. If the port default vian3 command is configured for the connected remote device, VLAN 3 between the two devices cannot communicate.
- C The peer port connected to the port must be configured with port trunk permit vlan all
- D. Allow all data frames of the VLAN to pass through the port. **(Right Answers)**

Answer: D

147_ The Hybrid port can connect to both the user host and other switches_

- A. True **(Right Answers)**
- B. False

Answer: A

148. The IP addresses of the VLANIF interfaces on the same switch cannot be the same.

- A. True **(Right Answers)**
- B. False

Answer: A

149. As shown in the following figure, the router uses the sub-interface as the gateway of the host. The P address of the gateway is 10.0.12.2 Which of the following commands can fulfill this requirement? (Multiple Choice)



- A interface GigabitEthernet0/0/43 10 dotq termination vid 10 ip address 100_122 255255 255 0 arp broadcast enable #
- B. interface Gi gabitEthernet0/0/0 20 dotq termination old 20 ip address 100_12 2 255255255 0 arp broadcast enable # **(Right Answers)**
- C. interface GigabitEthernet0/0/10 dotq termination vid 20 ip address 10.0.12.2 255.255.255.0 arp broadcast enable # **(Right Answers)**
- a interface GigabitEthernet0/0/020 dotq termination vid 10 ip address 10 0 12 2 255255 255 0 arp broadcast enable M

Answer: BC

150 The network administrator creates VLAN 10 on the Layer 3 switch and configures an IP address on the virtual interface of the VLAN. When you use the command *<i>|</i>display ip interface brief<i>|</i> to check the status of the interface and find that the VLANIF 10 interface is down, what operations should be taken to restore the VLANIF 10 interface?

- A Use the command "undo shutdown" on the VLANIF 10 interface.
- B. Incorporate a physical interface whose state must be Up into VLAN 10 **(Right Answers)**
- C Incorporate any physical interface into VLAN 10
- D. Incorporate an interface whose state must be Up and must be of the Trunk type into VLAN 10

Answer: B

151 As shown in the figure, the network administrator creates VLAN 2 on the SWA and SWB, and configures the ports connected to the host on the two switches as access ports and assigns them to VLAN 2. Configure G0/0/1 of the SA and G0/0/2 of the SWB as trunk ports to allow all VLANs to pass. To achieve normal communication between the two hosts, he also needs 0

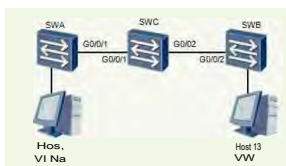

- A. Create VLAN 2 on the SWC.
- B. Configure G0/0/1 on the SWC as the trunk port and allow VLAN 2 to pass.
- C Configure G0/0/1 and G0/0/2 on the SWC as trunk ports and allow VLAN 2 to pass.
- D. Create VLAN 2 on the SWC, configure G0/0/1 and G0/0/2 as trunk ports and allow VLAN 2 to pass **(Right Answers)**

Answer:

152 As shown in the following figure, the switch configuration information is as follows. According to the network and configuration, which of the following statements are correct? (Multiple Choice)

```
Router B
interface Serial1/0/0
link-protocol ppp
ip address 10.0.21.1 255.255.255.0
```

```
ospf 1 router-id 10021.1
area 0.0.0.0
network 10.0.21.1 0.0.0.0
```

```
Router A
interface Serial1/0/0
link-protocol ppp
ip address 10.0.12.1 255.255.255.0
```

```
ospf 1 router-id 100.121
area 0.0.0.0
network 10.0.121.0 0.0.0.0
```

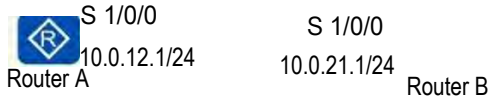

- A. Router A and Router B cannot team the MAC address of the other interface. (Right Answers)
- B. Router A and Router B have ARP tables.
- C. Two routers can establish OSPF adjacency (Right Answers)
- D. There is no OR and BOR in the network (Right Answers)

Answer: AGO

153 The data link layer uses PPP encapsulation, and the IP addresses at both ends of the link may not be in the same network segment

- A. True (Right Answers)
- B. False

Answer: A

154. The command to enable CHAP authentication in PPP is: ppp chap authentication.

- A. True
- B. False (Right Answers)

Answer: B

155. Apply the following ACL in SNMP: which of the following is wrong?

act number 2000

rule 5 permit source 192.168.1.2 0

rule 10 permit source 192.168.1.3 0

rule 15 permit source 192.168.1.4 0

- A. The device with IP address 192.168.1.5 can use SNMP service. (Right Answers)
- B. The device with IP address 192.168.1.3 can use SNMP service.
- C. The device with the IP address of 192.168.1.4 can use SNMP service.
- D. The device with IP address 192.168.1.2 can use SNMP service.

Answer: A

156. In the packet encapsulation format shown in the figure, which of the following fields will be encrypted by the ESP protocol of IPsec VPN?

- A. ESP Header, TCP Header, Data
- B. ESP Header, TCP Header, Data, ESP Trailer
- C. ESP Header, Tam Header, Data, ESP Trailer, ESP Auth
- D. TCP Header, Data, ESP Trailer (Right Answers)

Answer: D

157 As shown in the figure below, what is the scope of AH protocol authentication in IPsec transmission mode?

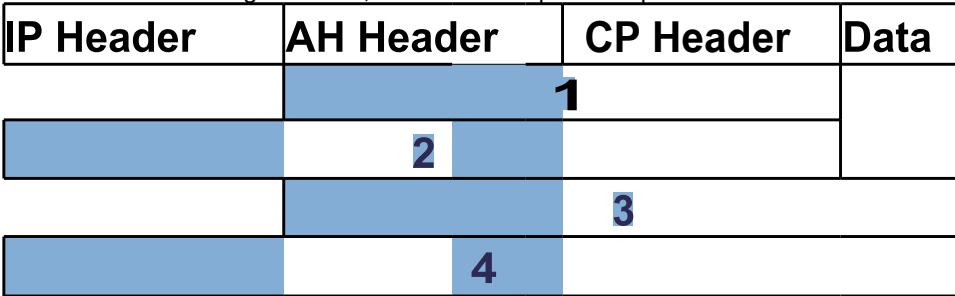

1=1 A. 1

ID B. 2

CI C. 3

D. 4 (Right Answers)

Answer: D

158. When the data encapsulation mode of IPsec is tunnel mode, the IP address of the intranet host is hidden, which can protect the security of the entire original data packet.

A. True (Right Answers)

B. False

Answer: A

159. Which of the following commands configures the authentication mode to be HWTACACS authentication?

A. authorization-mode hwtacacs

B. authentication-mode local

C. authentication-mode none

D. authentication-mode hwtacacs (Right Answers)

Answer: D

160. During the establishment of the adjacency relationship, what is the role of DD packets in OSPFv3?

A. Used to send the required LSA to the peer router

B. Discover and maintain neighbor relationships

C. To describe its own LSDB (Right Answers)

D. Request missing LSA

Answer: C

161. If the MAC address of an interface is 00E0-FCFF-FEEF-OFEC, what is its corresponding EUI-64 address?

A. 02E0-FCFF-FEEF-OFEC (Right Answers)

B. 00E0-FCEF-FFFE-OFEC

C. 00E0-FCFF-FFFE-OFEC

D. 00E0-FCFF-FEEF-OFEC

Answer: A

162. Which field of the IPv6 header can be used for QoS?

- A. Next Header
- B. Payload Length
- C. Traffic Class (Right Answers)
- D. Version

Answer: C

163. The simplest form of IPv6 address 3001:0DB8:0000:0000:0346:ABCD:42BC:8D58 is?

- A. 3001:0D138::0000:0346:ABCD:42BC:8D58
- B. 3001:DB8::346:ABCD:42BC:8D58 (Right Answers)
- C. 3001:DB8:0346:ABCD:42BC:81358
- D. 3001:0DB8:0346:ABCD:42BC:8D58

Answer: B

164. The same interface of the router cannot be used as both a DHCPv6 server and a DHCPv6

- A. True (Right Answers)
- B. False

Answer: A

165. Which packet is sent by the DI ICPv6 client, requesting the DI ICPv6 server to assign an IPv6 address and network configuration parameters to it?

- A. Solicit (Right Answers)
- B. Advertise
- C. Discover
- D. Request

Answer: A

166. Segment routing (SR) is a protocol based on what idea to design for forwarding packets on the network?

- A. Routing strategy
- B. Destination routing
- C. Policy routing
- D. Source routing (Right Answers)

Answer: D

167. How many bytes are the packets using the MPLS label double-layer nesting technology more than the original IP packets?

- A. 4
- B. 8 (Right Answers)
- C. 16
- D. 32

Answer: B

168. Which of the following subnet routes can aggregate from the route entry 10.0.0.24/29? (Multiple Choice)

- A. 10.0.0.24/30 (Right Answers)
- B. 10.0.0.26/30
- C. 10.0.0.28/30 (Right Answers)
- D. 10.0.0.23/30

Answer: AC

164. An IPv4 packet header length field is 20B. and the total length field is 1500B then what is the packet payload?

- A. 20B
- B. 1520B
- C. 1480B (Right Answers)
- D. 95000

Answer: C

170. Which of the following is unlikely to be the IPv4 packet header length?

- A. 208
- B. 64B (Right Answers)
- C. 608
- D. 328

Answer: B

171. The Ethernet optical interface can only work in the 0 mode.

- A. Full duplex (Right Answers)
- B. Half duplex
- C. Simplex
- D. Soft-negotiation

Answer: A

172 <Huawei>

Warning: Auto-Config is working. Before configuring the device, stop Auto-Config if you perform configurations when Auto-Config is running, the DHCP routing, DNS, and VTY configurations will be lost. Do you want to stop Auto-config? [Y/N]:

The administrator found that the above message popped up on the demo. The correct statement about this information is ().

- A. If you need to enable automatic configuration, the administrator needs to choose
- B. If you do not need to enable automatic configuration, the administrator needs to select N
- C. When the device is first started, the auto configuration function is enabled (Right Answers)
- D. When the device is first started, the auto configuration function is disabled.

Answer: C

173. Which of the following commands can be used to query the configuration information of the OSPF protocol? (Multiple Choice)

- A. display ip routing-table
- B. display current-configuration (Right Answers)
- C. display ospf peer
- D. In OSPF protocol view display this (Right Answers)

Answer: BD

174. The output information of a certain device is as follows. Which of the following statement is correct? (Multiple Choice)

```
<Huawei>display interface GigabitEthernet 0/0/0
GigabitEthernet0/0/0 current state : UP
Line protocol current state 7 LIFELINE
Route Port, The Maximum Transmit Unit is 1500
Internet Address is 10.0.12.2/29
IP Sending Frames' Format is PKTFIT_ETHNI_2, Hardware address is 00e0-fc224fff
Port mode: FORCE COPPER
Speed : 100, Loopback: NOW
Duplex: FULL, Negotiation: DISABLE
Echo : AUTO
Last 300 seconds input rate 24 bits/sec, 0 packets/sec
Last 300 seconds output rate 24 bits/sec, 0 packets/sec
```

- A. The MAC address of the interface is 00e0-fe22-4fff (Right Answers)
- B. The IP address of the interface is 10.0.12.2/24. (Right Answers)
- C. The working speed of this interface is 1Gbps_
- D. The MTU value of this interface is 1500. (Right Answers)

Answer: ABD

175. What is the correct statement about the black hole MAC address table? (Multiple Choice)

- A. The saved entries are not lost after the system is reset, the interface board is hot swapped, or the interface board is reset (Right Answers)
- B. It is manually configured and delivered to each interface board. The entries cannot be aged (Right Answers)
- C. After the blackhole MAC address is configured, the packet whose source MAC address or the destination MAC address is the MAC address will be discarded. (Right Answers)
- D. You can filter out illegal users by configuring blackhole MAC address entries. (Right Answers)

Answer: ABCD

176. Which is the correct statement about the static MAC address table? (Multiple Choice)

- A. After the interface is statically bound to the MAC address, the other interface receives the packet whose source MAC address is the MAC address will be discarded. (Right Answers)
- B. By viewing the static MAC address entry, you can determine whether there is data forwarding between the two connected devices.
- C. A static MAC address entry can be bound to only one outbound interface_ (Right Answers)
- D. The saved entries are not lost after the system is reset, the interface board is hot swapped, or the interface board is reset. (Right Answers)

Answer: AC0

177. In the RSTP protocol, when the root port fails, it will be quickly converted to the new root port and immediately enter the forwarding state.

- A. Backup port
- B. Edge port
- C. Forwarding port
- D. Alternate port (Right Answers)

Answer: D

178. Both the Alternate port and the Backup port in RSTP cannot forward user traffic in RSTP, but can receive, process, and send BPDUs.

- A. True (Right Answers)
- B. False

Answer: A

179. All switches in the following figure have STP protocol enabled, if the path cost of all ports is 200_ What is the path cost value included in the configuration BPDU received by the G0/0/4 port of SWD?

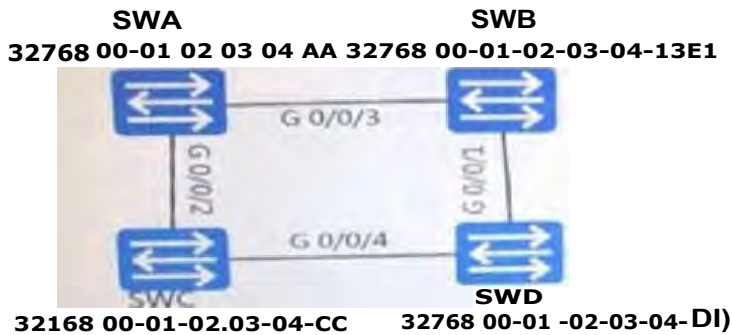

- A. 0
- B. 200 (Right Answers)
- C. 400
- D. 600

Answer: B

180 As shown in the figure, all four switches run STP, and various parameters use default values. When a port on the root switch sends a frame and fails to send configuration BPDUs through the port, how long before the blocked port in the network enters the forwarding state?



- A. About 30 seconds
- B. About 50 seconds (Right Answers)
- C. About 15 seconds
- D. About 3 seconds

Answer: B

181. By default, it takes at least 30 seconds for the port status in SW to be changed from disabled to forwarding.

- A. True (Right Answers)
- B. False

Answer: A

182. There are multiple NextHops in the routing table that reach the same destination network. These routes are called?

- A. Equivalent routing (Right Answers)
- B. Default route
- C. Multipath routing
- D. Suboptimal routing

Answer: A

183. Which of the following network types does the OSPF protocol need to elect DR and BDR? (Multiple Choice)

- A. Point-to-point type
- B. Broadcast type **(Right Answers)**
- C. NBMA **(Right Answers)**
- D. Point to point

Answer: BC

184. The Router ID of the OSPF process takes effect immediately after being modified.

- A. True
- B. False **(Right Answers)**

Answer: B

185. When configuring OSPF on a router, you must manually configure 0. (Multiple Choice)

- A. Enable OSPF process **(Right Answers)**
- B. Create an OSPF area **(Right Answers)**
- C. Configure the router ID
- D. Specify the network included in each zone **(Right Answers)**

Answer: ABD

186. The priority of the static routing protocol cannot be specified manually.

- A. True
- B. False **(Right Answers)**

Answer: B

187. Which of the following statements about direct route is correct?

- A. Direct route priority is lower than dynamic route
- B. Direct route requires the administrator to manually configure the destination network and next hop address.
- C. Direct route has the highest priority **(Right Answers)**
- D. Direct route priority is lower than static route

Answer: C

188. The router in the backbone area has all the LSDBs in all its areas.

- A. True
- B. False **(Right Answers)**

Answer: B

189. Which of the following parameters does the OSPF protocol use for the master-slave relationship election?

- A. Process number of OSPF protocol
- B. Router ID (Right Answers)
- C. Sequence of startup protocols
- D. Interface IP address

Answer: B

190. According to the following DHCP flowchart, which statements are true? (Multiple Choice)

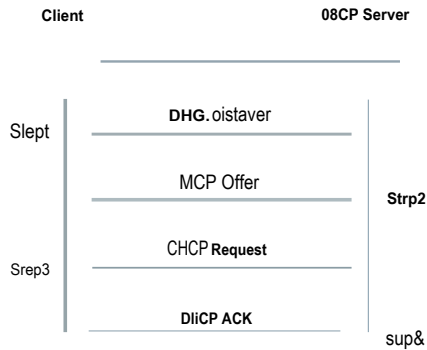

- A. In step 1, multicast packets are sent.
- B. In step 2, unicast packets are sent. (Right Answers)
- C. In step 3, broadcast packets are sent. (Right Answers)
- D. In step 4, unicast packets are sent. (Right Answers)
- E. In step 4, broadcast packets are sent.

Answer: BCD

191. The DHCP protocol interface address pool has a higher priority than the global address pool.

- A. TRUE (Right Answers)
- B. FALSE

Answer: T

192. As shown in the following figure, all links are Ethernet links, and all routers run OSPF. How many DR are elected in the entire network?



- A. 1
- B. 2
- C. 3
- D. 4 (Right Answers)

Answer: D

193. How many member ports can be added to an Eth-Trunk interface on ARG3 series router and X7 series switch?

- A. 6
- B. 8 (Right Answers)
- C. 10
- D. 12

Answer: B

194. A trunk port can send both tagged data frames and unlabeled data frames.

- A. TRUE (Right Answers)
- B. FALSE

Answer: T

195. As shown in the figure, if host A has host B ARP cache, host A can ping through host B.

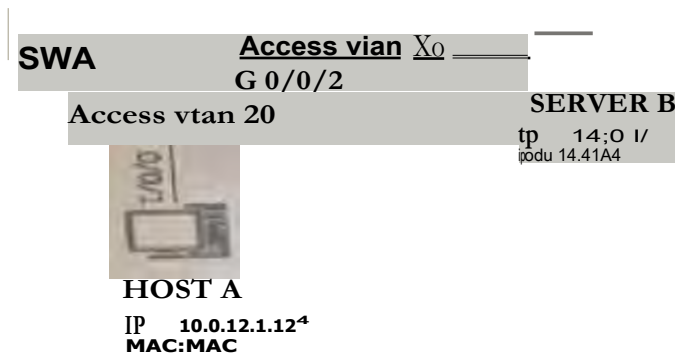

- A. TRUE
- B. FALSE (Right Answers)

Answer: F

196. Which of the following statements about one-arm routing is correct? (Multiple choice)

- A. One physical connection per VLAN
- B. On the switch, configure the port connected to the router as a trunk port and allow the frames of the relevant VLAN to pass. (Right Answers)
- C. Need to create a sub-interface on the router (Right Answers)
- D. Only one physical link is used between the switch and the router. (Right Answers)

Answer: BCD

197. Which of the following statements about link aggregation is correct? (Multiple choice)

- A. Eth-Trunk interfaces cannot be nested (Right Answers)
- B. Ensure that the modes of link aggregation on the two devices are the same when the two devices are connected to each other. (Right Answers)
- C. The GE interface and the FE interface cannot be added to the same Eth-Trunk interface. (Right Answers)
- D. GE electrical interfaces and GE optical interfaces cannot be added to the same Eth-Trunk interface. (Right Answers)

Answer: ABCD

198. NATP uses the same public IP address but different port numbers to translate private IP addresses. Which statement regarding the port number is correct?

- A. It is necessary to configure port number mapping manually.
- B. It is only necessary to configure the port number range.
- C. It is not necessary to configure port numbers.
- D. An access control list is needed to assign port numbers. (Right Answers)

Answer: D

199. Refer to the graphic.

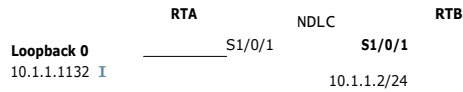

On the interface serial 1/0/1 of RTA, the command "ip address unnumbered interface loopback 0" has been configured. Which following statements are correct? (Multiple Choice)

- A. The IP address of RTA interface serial 1/0/1 is 10.1.1.1/24.
- B. The IP address of RTA interface serial 1/0/1 is 10.1.1.1/32. **(Right Answers)**
- C. The route entry 10.1.1.0/24 exists in RTA's routing-table.
- D. The route entry 10.1.1.0/24 does not exist in RTA's routing-table. **(Right Answers)**

Answer; BD

200. The data link layer is encapsulated in PPP. The IP addresses at both ends of the link cannot be in the same network segment.

- A. TRUE **(Right Answers)**
- B. FALSE

Answer: T

201. Which of the following parameters are identified by the SA (Security Association)? (Multiple choice)

- A. Source IP address
- B. Security Parameter Index (SPI) **(Right Answers)**
- C. Destination IP address **(Right Answers)**
- D. Security Protocol (AH or ESP) **(Right Answers)**

Answer; BCD

202. As shown in the following figure, IPSec uses tunnel mode. What is the scope of ESP encryption?

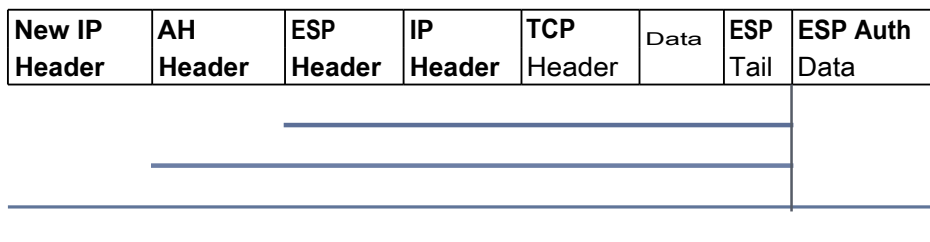

- A. 1 **(Right Answers)**
- B. 2
- C. 3
- D. 4

Answer, A

203. The Router-ID of OSPFv3 can be automatically generated by the system.

- A. TRUE **(Right Answers)**
- B. FALSE

Answer: F

204. The following about IPv6 stateless address autoconfiguration and DHCPv6, which is correct? (Multiple choice)
- A. IPv6 stateless address autoconfiguration uses RA and RS messages (Right Answers)
 - B. DHCPv6 is more manageable than stateless autoconfiguration (Right Answers)
 - C. DHCPv6 can be divided into DHCPv6 stateful autoconfiguration and DHCPv6 stateless autoconfiguration. (Right Answers)
 - D. IPv6 stateless address autoconfiguration and DHCPv6 can allocate related configuration information such as DNS address to the host.

Answer; ABC

205. Which of the following is the value of the IPv6 multicast address flag field indicates that the multicast address is a temporary multicast address?
- A. 0
 - B. 1 (Right Answers)
 - C. 2
 - D. 3

Answer. B

206. Which of the following is the value of the IPv6 multicast address flag field indicates that the multicast address is permanent multicast address?
- A. 0 (Right Answers)
 - B. 1
 - C. 2
 - D. 3

Answer. A

207. Based on tv1PLS labels, you can mark up to how many types of data streams with different service fevers?
- A. 2
 - B. 4
 - C. 8 (Right Answers)
 - D. 16

Answer: C

208. Segment Routing encodes the segment sequence representing the forwarding path in the packet header. As the packet is transmitted, the receiver parses the segment sequence after receiving the packet. If the top segment identifier of the segment sequence is the local node, the identifier is displayed, and then the next step is processed. It is not the local node, the packet is forwarded to the next node by using the ECMP (Equal Cost Multiple Path) mode.
 OA. TRUE (Right Answers)
 OB. FALSE

Answer: T

209. The router interface output information is as follows, which is correct? (Multiple choice)

```
(1-Turragei>display ipv6 interface GigabitEthernet 0/0/0
GigabitEthernet0/0/0 curront state : UP
1111 IPv6 protocol current state : UP
IPv6 is enabled, link-local address is Fd02::210:FCFF:FF6F:41r36
Global unicast address(es) :
  2001::12:1, subnet is 2001::/64
Joined group address(es)
  FE80::1:EF12:1
  FF02::2
  FF02::1
  FF02::1:FF6F:41'36
.....1111 is 1500 bytts
```

- A. The global unicast address of this interface is 2001::12:1 (Right Answers)
- B. The MTU of this interface is 1500_ (Right Answers)
- C. The link-local address of this interface is FE80: 2E0:FCFF FE6F:4F36 (Right Answers)
- D. The IPv6 protocol status of this interface is UP. (Right Answers)

Answer: ABCD

210. The output information of a router is as follows. What is the tunneling protocol used by this interface?

```
tar Altilsplay interface-Tunnel 0/0/0
ans10/0/0 current state : UP
Line protocol current state : Up
Last line protocol up time : 2019-03-06 11:03:15 11TC 0:::00
Description:HUAWEI, AR Series, Tunnel0/0/0 Interface
Mutes Port,The Maximum Transmit Unit is 1500
Internet Address is unnumbered. using address of Loopback0(1u.o.1.1432)
Encapsulation is TUNNEL. loopback not set
Tunnel source 10.0.12.1 GigabitEthernet0/45/0. destination 10.0.12.2
Tunnel protocol transport GRE/IP. key disabled
```

- A. MPLS
- B. IPsec
- C. LDP
- D. GRE (Right Answers)

Answer: D

211. What of the following statements is correct regarding Access Control List types and ranges?

- A. A basic ACL value ranges from 1000-2999.
- B. An advanced ACL value range from 3000-4000.
- C. A layer 2 ACL value ranges from 4000-4999. (Right Answers)
- D. An interface ACL value ranges 1000-2000.

Answer: C

212. The configuration information of router DHCP address pool is as follows. Which is correct? (Multiple choice)

```
ip pool test
```

```
network 192.168.1.0 mask 255.255.255.0
excluded-ip-address 192.168.1.200 192.168.1.254
lease day 0 hour 12 minute 0
```

- A. The address pool has 199 available IP addresses. (Right Answers)
- B. The lease of the IP address is 12h. (Right Answers)
- C. The address pool has 55 available IP addresses.
- D. The IP address that the DHCP client may obtain is 192.168.1.2. (Right Answers)

Answer: ABD

213. The output information of router routing table is as follows. Which is correct? (Multiple choice)

```

R1#show ip route
Route Flags: I - installed by this router, D - download to fib
-----
Mau Inc
  10.0.0.0/24
    Dime ince Iceno In Paw. tvp = $ 0
-----
boas i nationfiledeok Pro eel Ire Coal
  10.0.0.0/24
    10.6.2.1/24
-----

```

- A. The NextHop of this router reaching 90.0.0.1 is 10.0.21.2
- B. The NextHop of this router reaching 10.0.0.1 is 10.0.12.2 (Right Answers)
- C. The NextHop of this muter reaching 10.0.2.2 is 10.0.12.2
- D. The NextHop of this router reaching 10.0.2.2 is 10.0.21.2 (Right Answers)

Answer: BD

214 The following figure shows a routing table. When this router receives a packet with a destination IP address of 9.1.1.1, the router forwards the packet based on the route 9.1.0.0/16 because the matched bit number in this route is the largest

```

<Fluawei>#display ip routing-table
Route Flags: R - relay, D - download to fib

Routing Tables: Public Destinations : 2 Routes: 2
Destination/Mask Proto Pre Cost Flags NextHop Interface
0.0.0.0/0 Static 60 0 0 120.0.0.2 Serial11/0/0
8.0.0.0/13 RIP 100 3 0 120.0.0.2 Serial11/0/0
9.0.0.0/8 OSPF 10 50 0 20.0.0.2 Ethernet2/0/0
9.1.0.0/16 RIP 100 4 0 120.0.0.2 Serial11/0/0
11.0.0.0/8 Static 60 0 0 120.0.0.2 Serial12/0/0
20.0.0.0/9 Direct 0 0 0 20.0.0.1 Ethernet2/0/0
20.0.0.1/32 Direct 0 0 0 127.0.0.1 loopback0
OA: TRUE (Right Answers)
O B FALSE

```

Answer: T

215. Router 1 routing table output information is as follows; which is correct? (Multiple choice)

```

R1#show ip route
Route Flags: R - relay, D - download to fib
-----
Sna Te.ble. PeAdite
  10.0.0.0/24
    10.0.0.0/24
    10.0.2.2/24
    10.0.12.0/24
    10.0.12.1/24
-----
Prong Prc
  10.0.0.0/24
    10.0.0.0/24
    10.0.2.2/24
    10.0.12.0/24
    10.0.12.1/24
-----
Powe Pas e Poo
  10.0.0.0/24
    10.0.2.2/24
    10.0.12.0/24
    10.0.12.1/24
-----
toe or rasa
  10.0.0.0/24
    10.0.2.2/24
    10.0.12.0/24
    10.0.12.1/24
-----

```

- A. There are two dynamic routing protocols in the routing table. (Right Answers)
- B. The mask length of the IP address of the Ethernet0/0 interface on the router is 24 bits. (Right Answers)
- C. The IP address of the Ethernet0/0 interface on the router is 10.0.12.1. (Right Answers)
- D. There is a dynamic routing protocol in the routing table.

Answer: ABC

216. Refer to the display information.

```
CilLedwepchpley mac-address
-----
MAC Address      VIANNSI teamed-Frans Type
-----
5439-38ec-1518  If-      GE0/13(13)  dynamic
-----
Total lines displayed -1
```

A switch attempts to forward a frame to the MAC destination 54S9-98eo-1011
What operation will occur on the switch?

- A. The switch will send a request to obtain the MAC address of 5489-98ec-f011.
- B. The switch will report that the destination is unreachable and report this to the source.
- C. The switch will flood the frame via all ports, with exception of the port on which the frame was received. **(Right Answers)**
- D. The switch will drop the frame because it does not have an entry in its MAC address table.

Answer: C

217 The current switch MAC address table is as follows, which is correct?

MAC Address	TYPE	INTERFACE	TYPE
5489-9811-0b49	dynamic	Eth0/0/3	dynamic

- A. When the switch is restarted, the MAC address learned on pod Eth0/0/2 does not need to be re-learned.
- B. When the switch is restarted, the MAC address learned on pod Eth0/0/3 needs to be re-learned
- C The data frame with the source MAC address of 5489-9811-0b49 and the destination MAC address of 5489-989d-1430 is received from the pod and forwarded from Eth0/0/2_
- D The data frame with the source MAC address of 5489-98885-18a8 and the destination MAC address of 5489-989d-1d30 is received from the pod and forwarded from Eth0/0/1 **(Right Answers)**

Answer: D

218. If the transport layer protocol is UDP the network layer Protocol field takes a value of 6_

- OA. TRUE
- OB. FALSE **(Right Answers)**

Answer: F

219. Which of the following statements about gratuitous ARP packets are true? (Multiple Choice)

- A. A system can determine whether conflicting IP addresses are used by sending a gratuitous ARP packet. **(Right Answers)**
- B. A gratuitous ARP packet uses the same format as an ARP request packet. **(Right Answers)**
- C. A gratuitous ARP packet can help to update an IP address
- D. A gratuitous ARP packet uses the same format as an ARP reply packet.

Answer: AB

220. Which of the following flow control methods can be used in the transport layer of the OSI reference model? (Multiple choice)

- A Source suppression message **(Right Answers)**
- B. Window mechanism **(Right Answers)**
- C. Confirmation technology
- D Cache technology **(Right Answers)**

Answer: ABD

221. The application data must carry the MAC address after being processed by the data link layer.

- OA TRUE **(Right Answers)**
- OB. FALSE

Answer: T

222. A network engineer prompts the following message when entering the command line: Error: Unrecognized command found atw/position. Which is correct about this prompt message?
 D A. The input command is incomplete
 D B. No keywords found (Right Answers)
 D C. Input command is not clear
 LI D. Parameter type error

Answer: B

223. By default, the root path cost of the root bridge in the STP protocol must be 0.
 OA. TRUE (Right Answers)
 O B. FALSE

Answer: T

224. The output information of a switch is as follows. Which is correct?

```
01410wei@display mac-address
MAC address table of slot 0:
-----
MAC Address      VLAN/
VSI/SI          PEVLAN CRVLAN Port      Type      LSP/LSN-ID
MAC-Tunnel
-----
5489-9885-18e8
5489-9811-0b45 1          Eth0/0/3      static    -
-----
Total matching items on slot 0 displayed - 2
```

- O A. MAC 5489-9885-18a8 does not have corresponding port information, the switch appears BUG
- OB. All entries in the MAC address table are dynamically learned by the switch.
- OC. After the switch is restarted, MA C5489-9811-0b49 needs to be re-learned.
- OD. If the switch receives a data frame with a source MAC address or a destination MAC address of 5489-9885-18a8, the switch will discard the frame. (Right Answers)

Answer: D

225. Refer to the graphic.

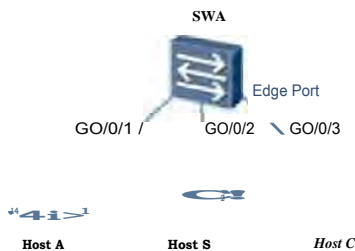

An administrator has configured the port interface GO/0/3 of Switch A as an edge port. The user wishes to connect multiple devices to the network and connects his own managed switch to the network. What effect will this have on the network?

- 111 A. Port interface GO/0/3 of switch A will shut down, as a BPDU has been received by the edge port.
- B. Port interface GO/0/3 of switch A will forward the data normally and drop the BPDU sent by the host to the switch.
- CI C. Switch A will receive the BPDU and recalculate the port state of GO/0/3. (Right Answers)
- O D. Only Host A can send data out as before, the other devices linked cannot.

Answer: C

226. Which of the following protocols can be used to avoid loops in a redundant Layer 2 network?

- EI A. ARP
- EI B. STP (Right Answers)
- CI C. UDP
- CI D. VRRP

Answer: B

227 The static MAC address table is reset in the system, after the interface board is hot swapped or the interface board is reset, saved entries are not lost.
 O A. TRUE (Right Answers)
 O B. FALSE

Answer: T

228 As shown in the following figure, assuming that the MAC address table of the SWA is as follows, now Host A sends a data frame whose destination MAC address is MAC-B. Which is correct?

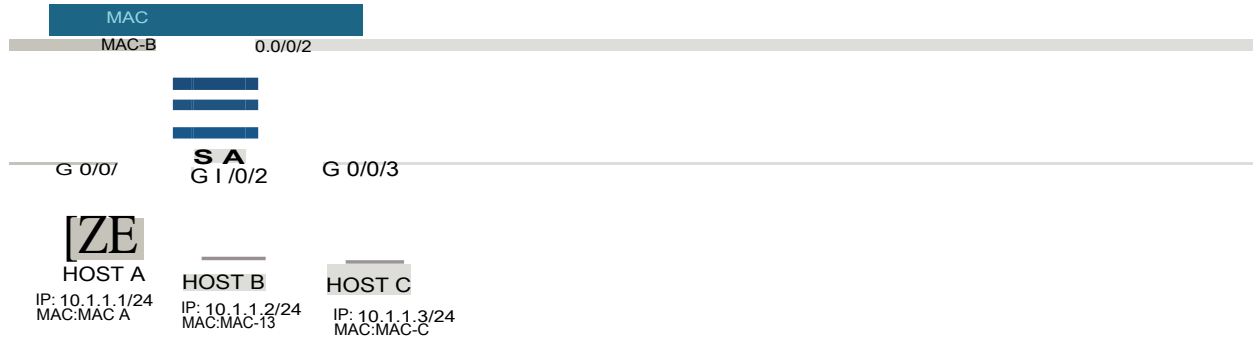

- A SWA discards data frames
- B Forward this data frame only from the G0/0/2 port (Right Answers)
- C Forward this data frame only from the G0/0/3 port
- D Generalize this data frame

Answer: B

229. As shown in the figure, STP is disabled on both switches, and Host A sends an ARP Request. Which is correct? (Multiple choice)

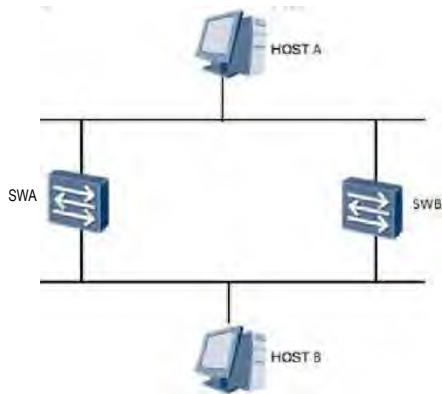

- A These two switches can achieve load balancing
- B. The CPU usage of these two switches will be very high. (Right Answers)
- C. Repeated frames will appear in this network (Right Answers)
- D. The MAC address table of these two switches will frequently jitter (Right Answers)

Answer: BCD

230. What are the three ways for a router to establish a routing table? (Multiple choice)

- A. Dynamic routing (Right Answers)
- B. Static routing (Right Answers)
- C. Direct routing (Right Answers)
- D. Aggregate routing

Answer: ABC

231. The output information of a router is as follows. Which is wrong? (Multiple choice)

```
<R1>display current-configuration configuration nspf
ospf 1 router-id 10.0.1.1
 area 0.0.0.0
  network 10.0.12.0 0.0.0.3
  network 10.0.12.0 0.0.0.255
N
return
<R1>display ospf peer

OSPF Process 1 with Router ID 10.0.12.1
Neighbors

Area 0.0.0.0 interface 10.0.12.1(GigabitEthernet0/0/0)'s neighbors
Router ID: 10.0.2.2      Address: 10.0.12.2
  State: Full Mode:Nbr is Slave Priority: 1
  DR: 10.0.12.2 BOR: 10.0.12.1 NTU: 0
  Dead timer due in 30 sec
  Retrans timer interval: S
  Neighbor is up for 00:01:48
  Authentication Sequence: [ 0 ]
```

- A. This router has enabled regional authentication. (Right Answers)
- B. The device is faulty. The configured Router Id is inconsistent with the actual Router ID. (Right Answers)
- C. The Router Id that is valid for this device is 10.0.12.1.
- D. The Router Id that is valid for this device is 10.0.1.1. (Right Answers)

Answer: ABD

232. As shown in the figure below, which is correct?

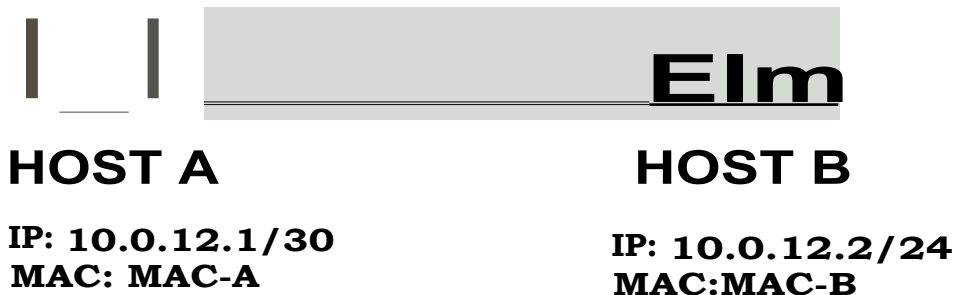

- A. Host A and host B have different IP address masks, so host A and host B cannot communicate.
- B. Host A and host B have the same broadcast address
- C. Host A and Host B can communicate only if the masks of Host A and Host B are set to be consistent.
- D. Host A can ping host B (Right Answers)

Answer: D

233. In which state does OSPF determine the master-slave relationship of DD packets?

- A. 2-way
- B. Exchange
- C. ExStart (Right Answers)
- D. Full

Answer: C

234. Which of the following VRP commands can be used to enter area 0 view? (Multiple Choice)

- A. [Huawei]ospf area 0
- B. [Huawei-ospf-l]area 0 (Right Answers)
- C. [Huawei-ospf-t]area 0.0.0.0 (Right Answers)
- D. [Huawei-ospf-l]area 0 enable

Answer: BC

235. As shown in the figure below, which is correct?



HOST A

HOST B

IP: 10.0.12.1/30
MAC: MAC-A

IP: 10.0.12.²/24
MAC:MAC-B

- A. Host A and Host B cannot obtain the MAC address each other. (Right Answers)
- B. Host A ARP cache exists 10.0.12.5 MAC-B
- C. Host A can ping host B
- D. Host A and host B have the same broadcast address

Answer: A

236. All interfaces of the router running OSPF must belong to the same area.

- OA. TRUE
- B FALSE (Right Answers)

Answer: F

237. On Huawei devices, which of the following methods can be used in OSPF router ID selection? (Multiple Choice)

- A. If a loopback interface is configured, the largest IP address of the loopback interface is selected as the router ID. (Right Answers)
- B. If loopback interfaces are not configured, the largest IP address of an interface is selected as the router ID. (Right Answers)
- C. A Huawei switch may use the largest IP address of VLANIF interfaces as the router ID. (Right Answers)
- D. The default ID 127.0.0.1 is selected as the router ID.
- E. A valid router ID can be configured manually. (Right Answers)

Answer: ABCE

238. Which of the following are the basic elements of configuring a static route? (Multiple choice)

- A. Destination network segment (Right Answers)
- B. MAC address of the outgoing interface
- C. IP address of the next hop (Right Answers)
- D. Outlet (Right Answers)

Answer: ACD

239. VRP operating platform, which of the following command can view the routing table?

- A. display ip routing-table **(Right Answers)**
- B. display current-configuration
- C. display ip interface brief
- D. display ip forwarding-table

Answer: A

240. The following two configuration commands can implement the router RTA to the primary and backup backups of the same destination 10.1.1.0:

[PTA] ip route-static 10.1.1.0 24 12.1.1.1 permanent

[RTA] ip route-static 10.1.1.0 24 13.1.1.1

OA. TRUE

B. FALSE **(Right Answers)**

Answer: F

241. What is the default server port number used by the Telnet protocol?

1:1 A. 21

B. 24

C. 22

D. 23 **(Right Answers)**

Answer: D

242. The maximum number of UTY user interfaces determines how many users can log in to the device through Telnet or STelnet.

OA. TRUE **(Right Answers)**

B. FALSE

Answer: T

243. Which of the following network parameters can the Dynamic Host Configuration Protocol DHCP assign? (Multiple choice)

A. Operating system

B. DNS address **(Right Answers)**

C. IP address **(Right Answers)**

D. Gateway address **(Right Answers)**

Answer: BCD

244. According to the topology and configuration shown in the figure, an Eth-Trunk link can be set up between the two switches on which LSW2 is the Actor.

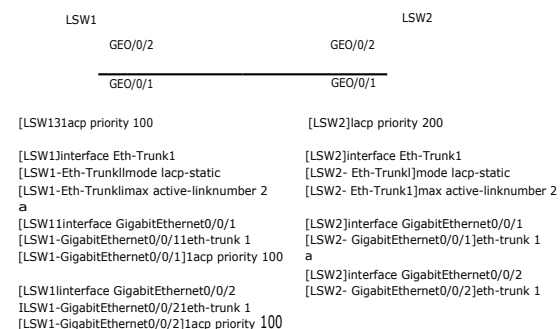

OA. TRUE

B. FALSE **(Right Answers)**

Answer: F

245 Referring to the configuration of the one-arm route in the following figure, it can be judged that even if the ARP proxy is not enabled on the sub-interface of R1, the administrative department and the finance department can exchange visits.

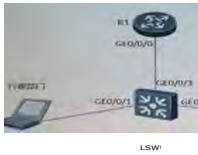

00 -Haurice_ eno/o/o.0a.no vod
 ge01171.0,000/0/0.1,lpacuresa 192.168.100056 255051.255.0
 ps.4154011100001/0/0.411.1,05 192.160200.250 255.255.215.0
 OA TRUE
 GB FALSE (Right Answers)

Answer: F

246. In the MAC address table of SWA and SWO, Ore MAC address, VLAN and port correspondence correct

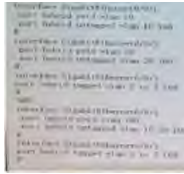

Device	Interface	MAC Address	VLAN	Port	MAC-A	MAC-B	
A SWA	20	GEO/013 MAC-C	100	GEOASIO	MAC-A	10	GEO/006 MA-B
B SW13	GEO10/3	MAC-C	030	GENION plight Ammar	MAC-A	10	GEO/02 MACLB
C SWA	GEO/02	MAC-C	100	GEO001) Right Answer	MAC-A	10	GEO11111 MAC-13
D SW13	GEO/043	MAC-C	11111	GEO/051	MAC-A	10	000/0/3 MAC-B

247. What is the value of the Flag field in the PPP frame format?

- A. 0xFF
- B. 0x7E (Right Answers)
- C. 0xEF
- 11. 0x8E

Answer: B

248. ICMP packets do not contain a port number, so NAPT cannot be used.

- OA. TRUE
- OB. FALSE (Right Answers)

Answer: F

249. If the network shown in the following figure requires the host A to access the Internet through Easy IP, which of the following ACL should be used on the G0/0/3 interface of Router A2

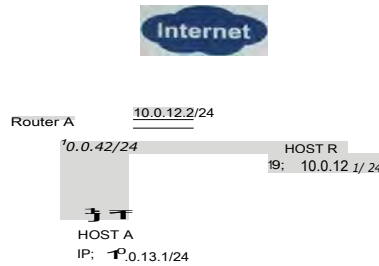

- A. acl number 2000 rule 5 permit source 11111112_1 000
- B. acl number 2000 rule 5 permit source 10.0.13.0 0.0.0.255# (Right Answers)
- C. acl number 2000 rule 5 permit source 19 0_15_1 0_0_0_0
- D. acl number 2000 rule 5 permit source 10 0 12 0 0 90 255#

Answer: B

250. As shown in the figure, the two private network hosts want to communicate with each other through the GRE tunnel. After the GRE tunnel is established, the network administrator needs to configure a static route on the RTA to import the traffic from host A to host B. The static routing channel can meet which of the following demands?



- A. ip route-static 10.2.0.24 tunnel 0/0/1 (Right Answers)
- B. ip route-static 10.1.0.24 200 1 1 1
- C. ip route-static 10.1.2024 GmabitEthernet0/0/1
- D. ip route-static 10.1.2.0.24 200 2.1

Answer: A

251. As shown in the figure below, which of the following locations should the AH header be inserted in the IPsec transport mode?



- A. 1
- B. 2
- C. 3
- D. 4 (Right Answers)

Answer: D

252. Which of the following remote login methods is the safest?

- A. Telnet
- B. Stelnet v100
- C. Stelnet v2 (Right Answers)
- D. Steinet vl

Answer: C

253. Which of the following default action business module ACL is permit?

- A. HTTP
- B. SNMP
- C. Telnet
- D. Flow strategy (Right Answers)

Answer: D

254. What is the Solicited-node multicast address corresponding to the IPv6 address 2019..8.AB?

- A. FF02::1:FF08:AB (Right Answers)
- B. FF02::FF08:AB
- C. FF02 1 tE08.AB
- D. FF 02:1:FF20: 19

Answer: A

255. What is the destination port number of the DHCPv6 request packet sent by the DHCPv6 client?

- A. 546
- B. 548
- C. 547 (Right Answers)
- D. 549

Answer: C

256. The OSPFv3 adjacency cannot be established. Which of the following reasons might be caused? (Multiple choice)

- A. Router-ID conflict (Right Answers)
- B. HELLO packet sending period is inconsistent (Right Answers)
- C. Inconsistent area numbers (Right Answers)
- D. Interface IPv6 address prefix is inconsistent

Answer: ABC

257. Which field is added to the SNMP packet header than the IPv4 packet header?

- A. Version
- B. Flow Label (Right Answers)
- C. Destination Address
- D. Source Address

Answer: B

258. LOP penultimate hop pop-up mechanism (PHP), which allows the label to be ejected on the penultimate hop LS11 This can reduce the packet processing complexity of which options?

- A. Last hop and penultimate hop device
- B. Penultimate hop device
- C. All MPLS network equipment
- D. Last hop device (Right Answers)

Answer: D

259. Which of the following MAC addresses cannot be used as the MAC address of the host NIG? (Multiple choice)

- A. 00-02-03-04-05-06
- B. 02-03-04-05-06-07
- C. 01_02_03_04_05_06 (Right Answers)
- D. 03-04-05-06-07-08 (Right Answers)

Answer: CD

260. Which of the following statements regarding the verification of IP connectivity are false? (Multiple Choice)

- A. The ping 12700_1 command can be used to check whether the network cable is correctly inserted into the host's Ethernet port (Right Answers)
- B. The ping command with the host IP address as the destination can be used to verify that the TCP/IP protocol suite is functioning correctly. (Right Answers)
- C. The ping command can be used to verify connectivity between the host and the local gateway.
- D. The command "ipconfig /release" can be used to check connectivity problems between the host and the local gateway (Right Answers)

Answer: ABD

261. Now there are four network segments 10.24.0.0/24, 10.24.1.0/24, 10.24.2.0/24, 10.24.3.0/24_ Which of the following network segments can be summarized? (Multiple choice)
- A. 10.24.0.0/23
 - B. 10.24.1.0/23
 - C. 10.24.0.0/22 (Right Answers)
 - D. 10.24.00/21 (Right Answers)

Answer: CD

262. The administrator wants to upgrade the configuration file for the AR2200 through the USB cable. Which is correct? (Multiple choice)
- E A. The AR2200 does not support the use of USB to update configuration files.
 - E B. Connect the USB interface of the PC and AR2200 with mini USB cable.
 - C. After connecting the cable, the administrator needs to install the driver for the mini USB. (Right Answers)
 - D. Connect the mini USB cable of the PC and AR2200 with mini USB cable. (Right Answers)

Answer: CD

263. The switch receives a micas' data frame. If the destination MAC address of the data frame can be found in the MAC local table, the data frame must be forwarded from the MAC corresponding port.
GA TRUE
rJB FALSE (Right Answers)

Answer, F

264. The output information of switch SW port is as follows: Which is wrong with the following statement?

```
Diumeildisplay stp interface Ethernet 0/0/1
_____ ECIST Global Info] iiodc SIN ----
CIST Bridge          :32768.4c1f-cc46-4618
Config Times         :Hello 4s MaxAge 20s FwdDly 15s JUL:Hop 20
Active Times         :Hello 2s MaxAge 20s FwdDly 15s XaxHop 20
CIST Root/ERPC      :0 .4c1f-cci7-3214 / 200000
CIST RegRoot /WPC   :32768.4c1f-cc46-4618 / 0
```

- A. The switch is not a root bridge
- B. Forward-delay is 20s (Right Answers)
- C. Configure the MaxAge of the BPDU to be 20s.
- D. The period for sending BPDU on this port is 2s.

Answer: B

- 265 The network shown in the figure below, all switches open STP. Disable the sending function of the BPDU on the G0/0/2 port of the SWA. The G0/0/1 of the SWC re-converges to become the root port. Which is correct? (Multiple choice)

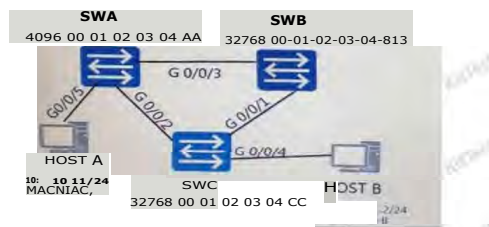

- A. SWB sends TCN BPDUs to SWA (Right Answers)
- B. SWC sends TCN BPDUs to SWB (Right Answers)
- C. SWB sends configuration BPDU with TCA set to SWC (Right Answers)
- D. SWA sends TC set configuration BPDU (Right Answers)

Answer: ABCD

266. An existing switch directly connects to a designated port of peer device through a poet, but the port does not forward any message, but can receive the BPDU to monitor the network change. The role of the port should be?

- A. Root port
- B. Designated port
- C. Alternate port (Right Answers)
- D. Disable Pod

Answer. C

267. The switch MAC address table is as follows, which is correct?

Dittasteildis aac-address
MAC address table of slot 0:

MAC Address	WAN/ VSI/SI	PEVLAN MILAN Port	Type	L.SP/LSR-ID NAC-Tunnel
5404-0885-18a8 1			b/aekbole	-
5484-9811-0b49 1		Etb0/0/3	static	-

Total matching items on slot 0 displayed = 2

MAC address table of slot 0:

MAC Address	IriAll/ VSI/SI	PEVLAN CEVLMI Part	Type	LSP/LSR-ID *AC-Tunnel
5489-18% d-2d30		Eth0/0/1	styrtaaric	0/-

Te401. amain, it...s on slot 0 displ_yed

- A. The switch receives the data frame with the destination MAC address of 5489-9811-0b49 will be discarded.
- B. The switch receives the data frame with the destination MAC address of 5489-9885-18a8 will be discarded. (Right Answers)
- C. The switch receives the data frame with the source MAC address of 5489-9811-0b49 and will be discarded.
- D. The switch receives the data frame with the destination MAC address of 5489-989d-1d30 will be discarded.

Answer: B

268. The device running STP will discard when it receives the configuration BPDU of RSTP.

- OA. TRUE (Right Answers)
- OB. FALSE

Answer: T

269. STP When the designated port receives a configuration BPDU that is worse than itself, it immediately sends its own BPDU downstream.

- OA. TRUE (Right Answers)
- OB. FALSE

Answer: T

270. What message is sent when the SW downstream device notifies the upstream device of topology change?

- A. TCA message
- B. TC message
- C. Configure BPDUs
- D. TGN BPDU (Right Answers)

Answer: D

271. Which flag bits of the STP protocol are not used by the Flag field in the RSTP configuration BPDU? (Multiple choice)

- A. Agreement (Right Answers)
- B. TCA
- C. TC
- D. Proposal (Right Answers)

Answer: AD

272. The backup port in RSTP can replace the failed root port.

- OA. TRUE
- OB. FALSE (Right Answers)

Answer: F

273. As shown in the following figure, the following configurations exist on the Router A. The following statements which are correct? (Multiple choice)
 ip route-static 10.0.2.2 255.255.255.255 10.0.12.2
 ip route-static 10.0.2.2 255.255.255.255 10.0.21.2 preference 40

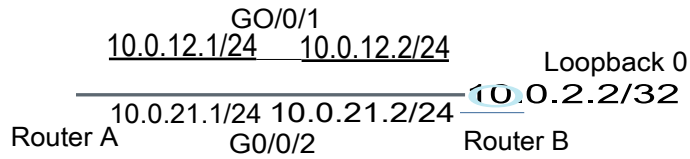

- O A. If the GO/0/2 port is Down, the interface that reaches 10.0.2.2 in the routing table of Router A is changed to GO/0/1. (Right Answers)
- D B. If the GO/0/1 port is Down, the interface that reaches 10.0.2.2 in the routing table of Router A is changed to GO/0/2.
- 0 C. the interface that reaches 10.0.2.2 in the routing table of Router A is GO/0/1.
- 0 D. the interface that reaches 10.0.2.2 in the routing table of Router A is GO/0/2. (Right Answers)

Answer: AD

274. VRRP supports OSPF multi-process. If no process number is specified when OSPF is enabled, the default process number is?
 EI A. 0
 EI B. 10
 EI C. 1 (Right Answers)
 P D. 100

Answer: C

275. The output information of a router is as follows. Which is correct? (Multiple choice)

```
1 >display ospf interface verbose
```

```
OSPF Process 1 with Router ID 10.0.1.1  
Interfaces
```

```
week: 0. 0. 0. 0          IRKS TE not enabled)
Interface: 10. 0.12. 1. (GisabilEthernet0/0/0)
=cost: 1          State: 5DR          Type: Broadcast          IITU: 1500
?priority: 1
Designated Router: 10.0.1.2. 2
Nackuv Designated Router: 10.0.12.1
Timers: Hello 10 Dead 40 . Poll 1.20 . Retransmit 5 , Transmit Delay 1
10 Statistics
      Type          Input          Output
      Hello          66             65
      DB Description  2              3
      Link-State Rto  0              1
      -State Update   3              2
      Link-State Mk    2              .
      MI GROUP
      R GROUP
      aqeId: 0 PrevState: Waiting
      time cost: 1, enabled by OSPF Protocol
```

- 1:1 A. The routing interface DR priority is 10.
- ID B. Router ID is 10.0.1.1 (Right Answers)
- EI C. The value of this interface Cost is "1" (Right Answers)
- EI D. This router is a BDR (Right Answers)

Answer: BCD

216. ip route-static 10.0.12.0 255.255.255.0 192.168.1 1

Which statement is true regarding this command?

- A. The configuration represents a static route to the 192.168.1.1 network.
- B. The configuration represents a static route to the 10.0.12.0 network (Right Answers)
- C. The preference value of this configured route is 100.
- D. If the router has learned the same destination network via a dynamic routing protocol, the static route will always take precedence.

Answer: B

277. Which state does OSPF use to indicate that a neighbor relationship has been established?

- A. 2-way (Right Answers)
- B. Down
- C. Attempt
- D. Full

Answer: A

278. By default, the period for sending OSPF HELLO packets on the broadcast network is?

- A. 10s (Right Answers)
- B. 40s
- C. 30s
- D. 20s

Answer: A

279. Which of the following problems may emerge when a loop exists on a router? (Multiple Choice)

- A. Infinite packet forwarding.
- B. Increased CPU usage. (Right Answers)
- C. Increased memory usage. (Right Answers)
- D. Continuous change of destination IP addresses of packets.
- E. Increased packet size.

Answer: BC

280. What are the roles of OSPF DR and BDR? (Multiple choice)

- A. Reduce the number of exchanges of link state information (Right Answers)
- B. Reduce the type of OSPF packets
- C. Reduce the time it takes for the adjacency to establish
- D. Reduce the number of adjacencies (Right Answers)

Answer: AD

281. The two routers are interconnected through the PPP link. The administrator configures OSPF on the two routers and runs in the same area. If their router IDs are the same, which is correct?

- A. Two routers will establish a normal full neighbor relationship
- B. Two routers will not send hello information to each other
- C. Two routers will establish a normal full adjacency
- D. VRRP will prompt the router ID conflicts of the two routers. (Right Answers)

Answer: D

282. Which of the following OSPF versions suit for IPv6?

- A. OSPFv1
- B. OSPFv3 (Right Answers)
- C. OSPFv4
- D. OSPFv2

Answer: B

283. The router R1 routing table output information is as follows, which is correct? (Multiple choice)

```
<RI>display ip routing-table
Route Flags: R – select, D – download to fib

Routing Tables: Public
Destinations : 13      Routes : 13

  nest into ion/Insk   Proto Pre Cost      Flags NextHop      Interface
-----
  0.0.0.0/0           Static 60 0           RD 10.0.14.4        Gigabit Ethernet 0/0/0
  10.0.0.0/8          Static 60 0           RD 10.0.12.2        It kerne t 0/0/0
  10.0.2.0/24         Static 00 0           RD 10.0.13.3        Ethernet0/0/2
  10.0.2.2/32         OSPF   10 00          RD 10.0.21.2        Et berm t0/0/1
```

- A. The router forwards the packet with the destination network of 12.0.0.0/8. (Right Answers)
- B. The packet with the destination network of 12.0.0.0/8 will be forwarded from the Ethernet0/0/0 interface of the router.
- C. The packet with the destination network of 11.0.0.0/8 will be forwarded from the GigabitEthernet0/0/0 interface of the router. (Right Answers)
- D. The router will drop the packet with the destination network of 11.0.0.0/8.

Answer: AC

284. The following election statement about DR and BDR, which is correct? (Multiple choice)

- A. If an interface has a priority of 0, the interface will not participate in the election of DR or BDR. (Right Answers)
- B. DR must exist in the broadcast network (Right Answers)
- C. If the priorities are the same, the router ID is compared. The larger the value, the higher the priority is elected as the DR. (Right Answers)
- D. BDR must exist in the broadcast network

Answer: ABC

285. A Windows host is started for the first time. If the address cannot be obtained from the DHCP server, which of the following IP addresses may the host use?

- A. 127.0.0.1
- B. 169.254.2.33 (Right Answers)
- C. 255.255.255.255
- D. 0.0.0.0

Answer: B

286. What is the main role of the DHCP DISCOVER message?

- A. The client is used to find the DHCP server. (Right Answers)
- B. The DHCP server responds to the DFHCP DISCOVER packet, which carries various configuration information.
- C. The server responds to the confirmation of the REQUEST message.
- D. The client requests configuration or renews the lease term.

Answer: A

287 As shown in the figure, the two hosts implement inter-machine communication through a single route. When the available G0/0/1.2 sub-interface receives the data frame sent by Host B to Host A, which of the following operations does the RTA perform?



via da
Gateway: 10.0.1254

via .
Gateway: 10.0.2.254

- A RTA will discard the data frame
- B RTA forwards the data frame directly through the G0/0/1.1 subinterface.
- C. After the RTA deletes the VLAN tag 20, it is sent out by the G0/0/1.1 interface.
- D The RTA first deletes the VLAN tag 20, then adds the VLAN tag 10, and then sends it out through the G0/0/1.1 interface (Right Answers)

Answer: D

288. What is the role of link aggregation? (Multiple choice)

- A. Implement load sharing (Right Answers)
- B. Facilitate analysis of data
- C. Increase bandwidth (Right Answers)
- D. Improve network reliability (Right Answers)

Answer: ACD

289. Which of the following is correct about link aggregation for LACP mode?

- A. The number of active ports cannot be set in LACP mode.
- B. All active interfaces in LACP mode participate in data forwarding and share load traffic.
- C. There are only up to 4 active ports in LACP mode.
- D. In LACP mode, devices at both ends of the link send LACP packets to each other. (Right Answers)

Answer: D

290. The following statement about the Hybrid port, which is correct?

- A. Hybrid port does not require PVID
- B. Hybrid port only receives data frames with VLAN TAG
- C. Hybrid port must carry VLAN TAG when sending data frames.
- D. The Hybrid port can strip the TAG of certain VLAN frames in the outbound direction. (Right Answers)

Answer: D

291_ In the process of establishing PPP link, which phase can be directly converted into by the Dead phase?

- A. Authenticate
- B. Terminate
- C. Establish (Right Answers)
- D. Network

Answer: C

292_ Which of the following values is used in the LengthType field of the Ethernet data frame, indicating that the packet carrying the PPPoE session phase is carried?

- A 0x8863
- B 0x8864 (Right Answers)
- C. 0x0800
- D. 0x0806

Answer: B

293. On theVRP platform, which command can set the encapsulation type of the data link layer of the Serial interface to HDLC?

- A. link-protocol hdlc (Right Answers)
- B. hdlc enable
- C. encapsulation hdlc
- D. link-protocol ppp

Answer: A

294. SNMPv1 defines five protocol operations.

- A. TRUE (Right Answers)
- B. FALSE

Answer: T

295. How many domains can be configured when configuring AM authentication on Huawei ARG3 series routers?

- A. 33
- B. 31
- C. 32
- D. 30 (Right Answers)

Answer: D

296. After the GRE keepalive function is enabled, the local end of the GRE tunnel periodically sends a keepalive packet to the peer every 10s.

- A. TRUE
- B. FALSE (Right Answers)

Answer: F

297.A The AAA protocol is the RADIUS protocol.

- A. TRUE
- B. FALSE (Right Answers)

Answer: F

298. The router Radius information is configured as follows: Which is correct? (Multiple choice)

- A. The [1³ address of the accounting server is 200.0.12.1 (Right Answers)
- B. The IP address of the authorization server is 200.0.12.1
- C. The source IP address of the router sending Radius packets is 200.0.12.2. (Right Answers)
- D. The IP address of the authentication server is 200.0.12.1 (Right Answers)

Answer: ACD

299. Which of the following SNMP protocols supports encryption?

- A. SNMPv2c
- B. SNMPv3 (Right Answers)
- C. SNMPv2
- D. SNMPv1

Answer: B

3011 Which packets are used by the DHCPv6 client and the DHCPv6 server to determine whether the client uses DHCPv6 stateful autoconfiguration or DHCPv6 stateless autoconfiguration? (Multiple choice)

- A. DA (Right Answers)
- B. NA
- C. NS
- D. RS (Right Answers)

Answer: AD

301. What is the destination port number of the DHCPv6 ADVERTISE packet sent by the DHCPv6 server?

- A. 548
- B. 547
- C. 549
- D. 546 (Right Answers)

Answer: D

302. When the DHCPv6 client receives the value of the 0 flag and the 0 flag in the RA message sent by the DHCPv6 server, the DHCPv6 client uses the DHCPv6 stateful auto configuration to obtain the IP address and other configuration information.

- A. TRUE (Right Answers)
- B. FALSE
- C. TRUE
- D. FALSE

Answer: A

303. 1/128 is the IPv6 Eui-64 address.

- A. TRUE (Right Answers)
- B. FALSE

Answer: A

304. On the network shown in the following figure, if the static route is configured on the RouterB, the NextHop corresponding to 2001::1/128 is in the routing table of RouterB.
ipv6 route-static 2001::1 128 3001:12:1

- A. 3001::12:2
- B. Te80:1903:c3fb
- C. 3002::12:1
- D. 3001:12:1 (Right Answers)

Answer: D

305. SR (Segment Routing) is attracting more and more attention as a new alternative MPLS tunneling technology. Many users hope to introduce SR technology to simplify network deployment and management and reduce CAPEX (Capital Expenditure). As the current mainstream tunneling technology, SR is widely used in bearer networks.

- A. TRUE (Right Answers)
- B. FALSE

Answer: A

306. The broadcast address is a special address in the network address where the host bits are all set to 1. It can also be used as a host address.
OA. TRUE
OB. FALSE (Right Answers)

Answer: F

307. As shown in the figure, if the administrator wants to improve the performance of this network, which of the following is the most appropriate?

- A. Use a switch to connect each host and change the working mode of each host to full duplex. (Right Answers)
- B. Use the Hub to connect each host and change the working mode of each host to half duplex.
- C. Use the Hub to connect each host and change the working mode of each host to full duplex.
- D. Use a switch to connect each host and change the working mode of each host to half duplex.

Answer: A

308. If the command is executed on the router: user-interface maximum-vty 0, the following statement which is correct?

- A. Support up to 4 users to access through VTY at the same time
- B. Support up to 15 users to access through VTY at the same time
- C. No user can log in to the router through Telnet or SSH. (Right Answers)
- D. Support up to 5 users to access through VTY at the same time

Answer: C

309. On the VRP operating platform, what is the command to display the current interface configuration in the interface view?

- A. display users
- B. display this (Right Answers)
- C. display ip interface brief
- D. display version

Answer: B

310. Regarding the conflict domain and the broadcast domain, the description which is correct? (Multiple choice)

- A. The device connected to a HUB belongs to a broadcast domain. (Right Answers)
- B. The device connected to a switch belongs to a conflict domain.
- C. The device connected to a switch belongs to a broadcast domain. (Right Answers)
- D. The device connected to a router belongs to a broadcast domain.
- E. The device connected to a HUB belongs to a conflict domain. (Right Answers)

Answer: ACE

311. What is the priority of the bridge priority in the IEEE 802.1D standard?

- A. 8 (Right Answers)
- B. 4
- C. 16
- D. 2

Answer: A

312. In RSTP mode, interfaces in the Discarding state discard received data frames but maintain the MAC address table based on received data frames.

- A. TRUE
- B. FALSE (Right Answers)

Answer: F

313. As shown in the figure below, which port of the following switch will become the designated port?

- A. SWC G01012
- B. SWB G0/0/3
- C. SWC G0/0/1
- D. SVVA G0/0/13 (Right Answers)

Answer: D

314. The device port running STP is in the Forwarding state. Which is correct?

- A. The port only receives and processes **BPDU** and does not forward user traffic.
- B. The port forwards both user traffic and BPDU. (Right Answers)
- C. The port does not process BPDU and does not forward user traffic.
- D. The port will build a MAC address table based on the received user traffic but will not forward user traffic.

Answer: B

315 As shown in the network below, the host has an ARP cache which is correct? (Multiple choice)

- k The router needs to be configured with static routes, otherwise Host A and Host B cannot communicate in both directions.
- B. Host A has the following entries in the ARP cache. 1110.12.2 MAC-C **(Right Answers)**
- C Host A has the following entries in the ARP cache_ 11_0_12 1 MAC-8
- D. Host A and Host B can communicate in both directions **(Right Answers)**

Answer: BD

316 In the network shown in the following figure, all routers run the OSPF protocol, and the top of the link is the value of the Cost value_ What is the Cost value of the RA) routing table that reaches the network 100m 0/87

- A. 70
- B. 20
- C. 60 **(Right Answers)**
- B. 100

Answer: C

317. As shown in the following figure, host A does not have a gateway configured. Host B has a gateway ARP cache. Which is correct? (Multiple choice)

- A. When the ARP proxy is enabled on G0/0/1 of the router, host A can communicate with host B.
- B. Host A and Host B cannot communicate in both directions **(Right Answers)**
- G Host B sends a packet with the destination IP address of 10 0 12 1 to he forwarded to host A **(Right Answers)**
- D Host A sends a packet with the destination IP address of 11_0 12 1 to be forwarded to host B

Answer: BC

318. In Huawei AR routers, by default, the value of the RIP priority is?

- A. 60
- n B. 120
- C. 100 **(Right Answers)**
- 0 D. 0

Answer: C

319. When OSPF establishes adjacency, which of the following must be consistent? (Multiple choice)

- A. Router Priority
- B. Router ID
- C. Router Dead Interval (Right Answers)
- D. Area ID (Right Answers)

Answer: CD

320. What are the advantages of the OSPF protocol? (Multiple choice)

- A. OSPF supports load balancing for equal-cost routes. (Right Answers)
- B. Supporting the division of regions (Right Answers)
- C. OSPF supports untyped inter-domain routing (CIDR) (Right Answers)
- D. OSPF supports packet authentication (Right Answers)

Answer: ABCD

321. What is the destination IP address of the DHCP DISCOVER packet?

- A. 224.0.0.2
- B. 127.0.0.1
- C. 224.0.0.1
- D. 255.255.255.255 (Right Answers)

Answer: D

322. If an Ethernet data frame has LengthType=0x8100, then the payload of this data frame cannot be? (Multiple choice)

- A. ARP response packet
- B. OSPF packet
- C. RSTP data frame (Right Answers)
- D. STP data frame (Right Answers)

Answer: CD

323. The configuration information of an interface of a router is as follows. Which port can receive the data packets of this VLAN?

- A. 100 (Right Answers)
- B. 20
- C. 30
- D. 1

Answer: A

324. What should I do when the trunk port sends a data frame?

- A. When the VLAN ID is different from the PVID of the port, the data frame is discarded.
- B. When the VLAN ID is different from the PVID of the port, replace it with PVID forwarding.
- C. When the VLAN ID is different from the PVID of the port, strip the TAG forwarding
- D. When the VLAN ID is the same as the PVID of the port and the VLAN ID is allowed to pass through the port, the tag is removed and the packet is sent. **(Right Answers)**

Answer: D

325. Which of the following features does HDLC have? (Multiple choice)

- A. HDLC protocol supports point-to-point links **(Right Answers)**
- B. HDLC protocol does not support FP address negotiation. **(Right Answers)**
- C. HDLC protocol supports point-to-multipoint links
- D. HDLC protocol does not support authentication **(Right Answers)**

Answer: ABD

326. The output information of a router is as follows. Which is correct? (Multiple choice)

- A. This interface is a synchronous interface **(Right Answers)**
- B. The IP address of the interface is 10.0.12.1124_ **(Right Answers)**
- C. The protocol used by the data link layer is PPP. **(Right Answers)**
- D. When the packet forwarded by this interface exceeds 1400 Byte, the packet needs to be fragmented.

Answer: ABC

327. The Protocol field in the PPP frame format is 0xC023, indicating that the protocol is?

- A. PAP **(Right Answers)**
- B. LCP
- C. CHAP
- D. NCP

Answer: A

328. What is the default ACL step size on the G3 series routers?

- A. 15
- B. 10 (Right Answers)
- C. 10
- D. 20

Answer: B

329. What is the range of advanced ACL?

- A. 6000-6031
- B. 4000-4999
- C. 3000-3999 (Right Answers)
- D. 2000-2999

Answer: C

330. Which of the following protocols is the IPsec VPN architecture?

- A. GRE
- B. ESP (Right Answers)
- C. IKE (Right Answers)
- D. AH (Right Answers)

Answer: BCD

331. About the matching mechanism of ACL, which is correct? (Multiple choice)

- A. If the ACL does not exist the result of returning the ACL is: no match (Right Answers)
- B. If the last rule is found and the packet still does not match, the ACL matching result is mismatch (Right Answers)
- C. Regardless of whether the result of the packet matching ACL is 'mismatch', 'allow' or 'deny', the packet is finally allowed to pass or refuse to pass, which is actually determined by each service module applying the ACL (Right Answers)
- D. By default, the rule with the lowest number in the ACL starts searching. Once the rule is matched, the subsequent rule is stopped. (Right Answers)

Answer: ABCD

332. The network management workstation manages the network device through the SNMP protocol. When the managed device has an abnormality, what kind of SNMP packet will the network management workstation receive?

- A. get-response message
- B. trap message (Right Answers)
- C. set-request message
- D. get-request message

Answer: B

333_ The router does not need to re-encapsulate the data link layer when forwarding GRE packets.

- A. TRUE
- B. FALSE (Right Answers)

Answer: B

334 There are 4 routers in a broadcast network, and all 4 routers run OSPFv3 protocol. If all router DR priorities are not 0, how many adjacencies are there in the network?

- A. 6
- B. 4
- C. 5 (Right Answers)
- D. 3

Answer: C

335. Which of the following statements about the Prefix Segment is wrong?

- A. Prefix Segment can be automatically assigned by IGP (Right Answers)
- B. Prefix Segment is spread to other network element through the IGP protocol. It is globally visible and globally valid.
- C. Prefix Segment requires manual configuration
- D. Prefix Segment is used to identify a destination address prefix in the network.

Answer: A

336. About the TTL field in the IPv4 header, which is correct?

- A. When a route has a loop, the TTL value can be used to prevent the packet from being forwarded indefinitely. (Right Answers)
- B. The TTL value is reduced by 1 for each Layer 3 device. (Right Answers)
- C. The TTL value is 8 bits long. (Right Answers)
- D. The range of TTL values is 0-255 (Right Answers)

Answer: ABCD

337. What is the value range of the DSCP field in the IPv4 header?

- A. 0-15
- B. 0-63 (Right Answers)
- C. 0-31
- D. 0-7

Answer: B

338. UDP is connectionless and must use which to provide the reliability of the transmission?

- A. Network layer protocol
- B. Application layer protocol (Right Answers)
- C. Transmission Control Protocol
- D. Internet Protocol

Answer: B

339. Because the TCP protocol uses three-way handshake mechanism when establishing and closing connections, TCP supports reliable transmission.

- OA. TRUE
- OB. FALSE (Right Answers)

Answer: F

340. Which method VRRP does not support to configure the router?

- A. Configure the router through Telnet
- B. Configure the router through the mini USB port
- C. Configure the router through the console port.
- D. Configure the router through FTP (Right Answers)

Answer: D

341. In which view can the administrator modify the device name for the router?

- A. Protocol-view
- B. System-view (Right Answers)
- C. User-view
- D. Interface-view

Answer: B

342. Which of the following states does the STP protocol elect to perform port roles?

- A. Blocking
- B. Disabled
- C. Learning
- D. Listening (Right Answers)

Answer; D

343. What is the total length of the Rag field in the RSTP BPDU message?

- A. 6
- B. 4
- C. 8 (Right Answers)
- D. 2

Answer: C

344. Which of the following is not the reason that RSTP can improve the convergence speed?

- A. Introduction of edge ports
- B. Canceled Forward Delay (Right Answers)
- C. Fast switching of the root port
- D. PIA mechanism

Answer: B

345. Which of the following statements about the edge port in the RSTP protocol is correct?

- A. The edge port can be directly transferred from the Disable state to the Forwarding state. (Right Answers)
- B. The ports interconnected between the switches need to be set as edge ports.
- C. The edge port discards the received configuration BPDU packet.
- D. Edge port participates in RSTP operation

Answer: A

346. A switch running STP can be converted to the Forwarding state after waiting for the forwarding delay in the Learning state.
OA. TRUE (Right Answers)
B FALSE

Answer: T

347. In Huawei AR routers, what is the priority of the static routing protocol by default?
 A. 60 (Right Answers)
 B. 100
 C. 120
 D 0

Answer: A

348. As shown in the following figure, all routers run OSPF. Which device ABR?

- A. Router D
- B. Router C
- C. Router A (Right Answers)
- D. Router B (Right Answers)

Answer: CD

349 As shown in the following figure, if the host has an ARP cache and host A sends a packet to host B, what is the destination MAC address and destination P address of the packet?

- A. MAC-C 10 0 12 2
- B. MAC-A 11 0.12 1
- C. MAC-C 11 0 12 1 (Right Answers)
- B. MAC-B 11 0.12.1

Answer: C

350. What types of networks are supported by the OSPF protocol? (Multiple choice)

- A. Point-to-Multipoint **(Right Answers)**
- B. Non-Broadcast Multi-Access **(Right Answers)**
- C. Point-to-Point **(Right Answers)**
- D. Broadcast **(Right Answers)**

Answer: ABM

351. How many types of OSPF packets are there?

- A. 3
- B. 4
- C. 5 **(Right Answers)**
- D. 2

Answer: C

352. When upgrading the router software using the FTP protocol, which transfer mode should be selected?

- A. Text mode
- B. Byte mode
- G. Streaming byte mode
- D. Binary mode **(Right Answers)**

Answer: D

353. Which message does the DHCP server use to confirm that the host can use the IP address?

- A. DHCP ACK **(Right Answers)**
- B. DHCP DISCOVER
- C. DHCP REQUEST
- D. DHCP OFFER

Answer: A

354. A Windows host is started for the first time. If the IP address is obtained by DHCP, what is the source IP address of the first packet sent by this host?

- A. 127.0.0.1
- B. 255.255.255.255
- C. 0.0.0.0 **(Right Answers)**
- D. 169.254.2.33

Answer: C

355. What is the range of VLAN IDs that users can use?

- A. 0-4096
- B. 1-4096
- C. 1-4094 (Right Answers)
- D. 0-4095

Answer: C

356. If a port has the following configuration information, which port does the VLAN TAG carry when transmitting data frames of the VLAN?

- A. 1,2,3,100
- B. 2,3,4,6,100
- C. 2,3,100 (Right Answers)
- D. 1,2,3,4,6,100

Answer: C

357. The load balancing modes of the two ends of the Eth-Trunk can be inconsistent.

OA. TRUE (Right Answers)

OB. FALSE

Answer: T

358. For the network shown in the following figure, the switch uses the sub-interface pair of the machine interface and the router. Which of the following configurations can fulfill this requirement?

- A. interface 10 ip address 10.0.12.1 255.255.255.0 # interface GigabitEthernet0/0/2 pod link-type hybrid pod hybrid untag Nan 10 #
- B. interface Mandl0 ip address 10.0.12.1 255.255.255.0 # interface GigabitEthernet0/0/2 pod link-type trunk pod trunk allow-pass Nan 10 # (Right Answers)
- C. interface Menai() ip address 10.0.12.1 255.255.255.0 # interface GigabitEthernet0/0/2 pod link-type access port default Nan 10 #
- D. interface Vlanif10 ip address 10.0.12.1 255.255.255.0 # interface GigabitEthernet0/0/2 pod link-type trunk pod trunk paid 10 pod trunk allow-pass Nan 10 #

Answer: B

359. In the following options, which is the necessary technology to enable a host with an IP address of 10.0.0.1 to access the Internet?

- A. Dynamic routing
- B. NAT (Right Answers)
- C. Route introduction
- D. Static routing

Answer: B

360 As shown in the following figure, from the perspective of the security corner, Router A refuses to receive OSPF packets, GRE packets and IGMP packets received from GO/0/1 Which of the following commands can fulfill this requirement? (Multiple choice)

- A. act number 3000 rule 5 deny gre rule 10 deny ospf rule 15 deny icmp # interface GmabliEthernet0/0/1 traffic-filter inbound act 3000 # (Right Answers)
- B. act number 3000 rule 5 deny gre rule 10 deny 89 rule 15 deny icmp # interface GmabliEthernet0/0/1 traffic-filter inbound act 3000 # (Right Answers)
- C. act number 2000 rule 5 deny 47 rule 10 deny 89 rule 15 deny 1 # interface GmabliEthernet0/0/1 traffic-filter inbound eel 2000 #
- D. act number 3000 rule 5 deny 47 rule 10 deny 89 rule 15 deny 1 # interface GmabliEthernet0/0/1 traffic-filter inbound ad 3000 # (Right Answers)

Answer: ABO

361 As shown in the following figure, which of the following configurations can be used to prevent Host A from accessing Host B HTTP service. Host B can not access which service of Host A HP? (Multiple choice)

- A. acl number 3000 rule 5 deny tcp source 100.0.12.0/24 destination 100.0.13.0/24 destination-port eq www # interface GigabitEthernet0/0/1 traffic-filter inbound act 3000 # interface GigabitEthernet0/0/2 traffic-filter outbound ark 31031 #
- B. act number 2000 rule 5 deny tcp source 180.0.13.0/24 destination 100.0.12.0/24 destination-port eq www # interface GigabitEthernet0/0/1 traffic-filter inbound 1113000 # interface GigabitEthernet0/0/2 traffic-filter inbound eel 3001 # (Right Answers)
- C. act number 3000 rule 5 deny tcp source 100.0.13.0/24 destination 100.0.12.0/24 destination-port eq www # acl number 3001 rule 5 deny tcp source 100.0.12.0/24 destination 100.0.13.0/24 destination-port eq www # interface GigabitEthernet0/0/1 traffic-filter inbound 1013000 # interface GigabitEthernet0/0/2 traffic-filter outbound ael 3001 #
- D. act number 3000 rule 5 deny tcp source 100.0.12.0/24 destination 100.0.13.0/24 destination-port eq www # interface GigabitEthernet0/0/1 traffic-filter inbound 3013000 # interface GigabitEthernet0/0/2 traffic-filter inbound eel 3001 # (Right Answers)

Answer: HD

362. 0 packets are carried over TCP.

- A. TRUE
- B. FALSE (Right Answers)

Answer: F

363. The multicast address FF02::1 represents all nodes in the link-local range.

- A. TRUE (Right Answers)
- B. FALSE

Answer: T

365. In the establishment of adjacency relationship, what is the role of DD packets in OSPFv3?

- A. Request missing LSA
- B. Used to send the required LSA to the peer router
- C. Discover and maintain neighbor relationships
- D. To describe your own LSDB (Right Answers)

Answer: D

366. The simplest form of IPv6 address 3001: 0DB8: 0000: 0000: 0346: ABCD: 42BC: 8D58 is?

- A. 3001:0DB8::0000:0346:ABCD:42BC:8D58
- B. 3001: DB8::0346: ABCD: 42BC: 8058
- C. 3001: D68::346: ABCD: 4260: 8058 (Right Answers)
- D. 3001:0DB8::0346:ABCD:42BC:8D58

Answer: C

367. When the host adopts DHCPv6 stateless autoconfiguration, which DHCPv6 message is sent by the host to request configuration information?

- A. Information-Request (Right Answers)
- B. CONFIRM
- C. SOLICIT
- D. REBIND

Answer: A

368. What is the length of the IPv6 multicast address flag field?

- A. 3
- B. 2
- C. 4 (Right Answers)
- D. 5

Answer: C

36g. Which of the following statements about the Node Segment is wrong?

- A. The Node SID cannot be the same as the node Prefix SID. (Right Answers)
- B. Node Segment is used to identify a specific node
- C. Configure the IP address as the prefix on the loopback interface of the node. The Prefix SID of this node is actually the Node SID.
- D. Node Segment is a special Prefix Segment

Answer: A

370. Which of the following are the actions of the MPLS (Multiple choice)

- A. pop (Right Answers)
- B. switch
- C. swap (Right Answers)
- D. puch (Right Answers)

Answer: ACD

371. If two Huawei S5710 switches are interconnected using a 10 Gigabit optical module, the working mode of the interconnect port defaults to full duplex.

- OA. TRUE (Right Answers)
- OB. FALSE

Answer: T

372. On the Huawei ARG3 router, the -i parameter of the Ping command in the VRP is used to set ?

- A. Interface for sending Echo Request packets (Right Answers)
- B. Source IP address for sending Echo Request packets
- C. Interface for receiving Echo Reply packets
- D. Destination IP address of receiving Echo Reply packets

Answer: A

373. The following statement about the TTL field in the IP packet header, which is correct?

- A. TTL defines the number of packets that the source host can send.
- B. Whenever a packet passes through a router, its TTL value is decremented by 1. (Right Answers)
- C. TTL defines the time interval at which the source host can send packets.
- D. Whenever a packet passes through a router, its TTL value will be increased by 1.

Answer: B

374. Which of the following statements about ICMP messages is correct? (Multiple choice)

- A. The length of the Type field in the ICMP packet format is 8 bits. (Right Answers)
- B. The length of the Checksum field in the ICMP packet format is 8 bits.
- C. The value of the ICMP packet in the first protocol type field of IPv4 is 1. (Right Answers)
- D. The length of the Code field in the ICMP packet format is 8 bits. (Right Answers)

Answer: ACD

375. How does the VRP platform represent the third slot of the router, the sub-card No. 0 and the GE port No. 2.

- A. interface GigabitEthernet 3/2/0
- B. interface Ethernet 3/0/2
- C. interface XGigabitEthernet 3/0/2
- D. interface GigabitEthernet 3/0/12 (Right Answers)

Answer: D

376. Which of the following statements about the Spanning Tree Protocol Root Bridge election is correct?

- A. When the bridge priority is the same, the device with the large MAC address becomes the root bridge.
- B. When the bridge priority is the same, the device with a large number of ports becomes the root bridge.
- C. The device with a smaller bridge priority value becomes the root bridge. (Right Answers)
- D. The bridge with a higher priority value becomes the root bridge.

Answer: C

377. In standard STP mode, which of the following ports on non-root switches forward the BPDUs with TC bits set generated by the root switch?

- A. Root port.
- B. Backup port.
- C. Provisioning port
- D. Designated port (Right Answers)

Answer: D

378. The Message Age in the configuration BPDU sent by the root bridge in the STP protocol is 0.

- A. True (Right Answers)
- B. False

Answer: A

37g. Which of the following parameters should be considered when electing a root port in STP? (Multiple choice)

- A. Duplex mode of the port
- B. Port priority (Right Answers)
- C. the cost of the port reaches the root switch (Right Answers)
- D. MAC address of the port
- E. Port slot number, such as GO/0/1 (Right Answers)

Answer; BCE

380. As shown in the following figure, assume that all routers run OSPF at the same time. Which kind of router is BDR in this network?

- A. Router A (Right Answers)
- B. Router B
- C. Router C
- D. Router D

Answer: A

381. The routing table shown below, which of the following statement is correct? (Multiple choice)

- A. The NextHop of the destination network 10.0.3.3/32 is not directly connected, so the router will not forward the packet with the destination IP address of 10.0.0.3.
- B. The router forwards the packet with the destination IP address 10.0.2.2 from Ethernet0/0/10. (Right Answers)
- C. The router forwards the packet with the destination IP address 10.0.12.1 from Ethernet0/0/0.
- D. The router forwards the packet with the destination IP address 10.0.0.3 from Ethernet0/0/0. (Right Answers)

Answer: BD

382. As shown in the figure below, which network device can Host A and Host B use to communicate?

- A. Router (Right Answers)
- B. Hub
- C. HUB
- D. II Layer 2 switch

Answer: A

383. The router output information is as follows, which of the following statement is wrong?

- A. The MTU value of the Ethernet0/0/0 interface is 1480. **(Right Answers)**
- B. The physical link of Ethernet0/0/0 is normal.
- C. The broadcast address corresponding to the Ethernet0/0/0 interface is 10.0.12.255.
- D. The IP address of the Ethernet0/0/0 interface is 10.0.12.1/24.

Answer: A

384. Which of the following is not included in the routing table?

- A. Next hop
- B. Routing cost
- C. Source address **(Right Answers)**
- D. Target network

Answer: C

385. Which of the following statement about the OSPF backbone area is correct?

- A. Area 0 is the backbone area. **(Right Answers)**
- B. All areas can be backbone areas
- C. The backbone area must be deployed when the number of routers running OSPF exceeds two.
- D. All routers in the backbone area are ABR

Answer: A

386. What are the advantages of the OSPF protocol? (Multiple choice)

- A. OSPF supports load balancing for equal-cost routes. **(Right Answers)**
- B. OSPF supports Classless inter-domain routing (CIDR) **(Right Answers)**
- C. OSPF supports packet authentication **(Right Answers)**
- D. Supporting the division of areas **(Right Answers)**

Answer: ABCD

387 A DHCP server in the enterprise network is being used to allocate IP addresses to hosts. An administrator discovers however that some hosts are obtaining IP addresses outside of the scope of the DHCP servers address pool. What are the possible reasons for this? (Multiple Choice)

- A. All addresses from the DHCP pool have been assigned. (Right Answers)
- B. The hosts were unable to discover a DHCP server and therefore generated their own address in the 169.254.0.0 address range. (Right Answers)
- C. Another DHCP server exists in the network and is allocating IP addresses to hosts that happen to be within a closer proximity than the authorized DHCP server (Right Answers)
- D. The hosts were unable to discover a DHCP server and therefore generated their own address in the 127.254.0.0 address range.

Answer: ABC

388.[Huawei]user-interface vty 0 14

[Huawei-ui-vty0-14] acl 2000 inbound

[Huawei-ui-vty0-14] user privilege level 3

[Huawei-ui-vty0-14] authentication-mode password

Please configure the login password (maximum length 16): Huawei

The configuration of vty is as shown above, and the user privilege level is set to level 3.

- A. True (Right Answers)
- B. False

Answer: A

389. The aggregation port of the router can be configured with a routing subinterface.

- A. True (Right Answers)
- B. False

Answer: A

390. Which VLAN partitioning method is most appropriate when the host frequently moves the location?

- A. Based on IP subnetting
- B. Based on MAC address division (Right Answers)
- C. Basic strategy division
- D. Port-based partitioning

Answer: B

391. On the VRP platform, the role of the command "interface vlan <vlan-id>" is 0.

- A. Create or enter the VLAN virtual interface view. (Right Answers)
- B. Create a VLAN
- C. No such command
- D. Configure a VLAN for a port

Answer: A

392_ NAPT distinguishes the IP addresses of different users by protocol numbers in TCP or UDP or IP packets.

- A. True
- B. False (Right Answers)

Answer: B

393. Which message need to send when needing to terminate a PPPoE session?

- A. PADR
- B. PADT (Right Answers)
- G. PADO
- D. PADI

Answer: B

394. Which of the following are the advantages of the PPP protocol? (Multiple choice)

- A. PPP protocol supports negotiation of link layer parameters (Right Answers)
- B. PPP protocol supports negotiation of network layer parameters (Right Answers)
- C. PPP protocol supports both synchronous transmission and asynchronous transmission. (Right Answers)
- D. PPP protocol supports authentication (Right Answers)

Answer: ABCD

395 The network shown below. Which of the following configurations enables all hosts to communicate with Host C, but Host A and Host B cannot communicate?

- A. act number 4000 rule 5 deny destination mac 5439-93ea-4010 source-mac 5489-9843-104d # interface GigabitEthernet0/0/1 traffic-filter inbound acl 4000 #
- B. act number 4000 rule 5 deny destination-mac 5489-98e8-4c7c source-mac 5489-98d3-104d # interface GigabitEthernet0/0/1 traffic-filter outbound act 4000 #
- C. act number 4000 rule 5 deny destination-mac 5439-98ca-4c7c source-mac 5489-9300-550e # interface GigabitEthernet10/0/1 traffic-filter inbound act 4000 # (Right Answers)
- B. act number 4000 rule 5 deny destination-mac 5489-983a-400 source-mac 5489-98c0-550e # interface GigabitEthernet0/0/1 traffic-filter outbound acl 4000#

Answer: C

396. As shown in the figure: IPsec VPN is used to transfer data between two hosts. In order to hide the real IP address and ensure the security of data as high as possible, which mode and protocol of IPsec VPN is better? (Multiple choice)

- A. All
- B Tunnel mode (Right Answers)
- a Transmission mode
- B. ESP (Right Answers)

Answer: BD

397. Apply the following ACL in Telnet: which of the following statement is correct?

acl number 2000

rule 5 deny source 172.16.105.30

rule 10 deny source 172.16.105.40

rule 15 deny source 172.16.105.50

rule 20 permit

- A. The device with IP address 172.16.105.6 can use the Telnet service. **(Right Answers)**
- B. The device with IP address 172.16.105.3 can use the Telnet service.
- C. The device with IP address 172.16.105.5 can use the Telnet service.
- D. The device with IP address 172.16.105.4 can use the Telnet service.

Answer: A

398. Which of the following IPv6 addresses is a link-local address?

- A. FC00::2E0: FCFF: FEEF: FEC
- B. FE80::2E0: FCFF: FEEF: FEC **(Right Answers)**
- C. 2000::2E0: FCFF: FEEF: FEC
- D. FF02::2E0: FCFF: FEEF: FEC

Answer: B

399. Which field in the Fv6 header acts like the TTL field in the IPv4 header?

- A. Version
- B. Traffic Class
- C. Hop Limit **(Right Answers)**
- D. Next Header

Answer: C

400. What are the three main roles in the DHCPv6 basic protocol architecture? (Multiple choice)

- A. DHCPv6 switch
- B. DHCPv6 relay **(Right Answers)**
- C. DHCPv6 client **(Right Answers)**
- D. DHCPv6 server **(Right Answers)**

Answer: BCD

401. The value of the MO flag in the RA message sent by the DHCPv6 service is 01. Which of the following methods does the host use to automatically configure the address?

- A. Value does not make any sense
- B. DHCPv6 stateless autoconfiguration **(Right Answers)**
- C. DHCPv6 stateful autoconfiguration
- D. Stateless autoconfiguration

Answer: B

402. Which of the following statements about the S field in the MPLS packet header is correct? (Multiple choice)

- A. Is there any other label after marking this label, 1 means yes, 0 means no
- B. The S bit exists in each MPLS packet header. (Right Answers)
- C. Is there any other label after marking this label, 0 means yes. 1 means no (Right Answers)
- D. S bit has only 1 bit in frame mode and 2 bits in cell mode.

Answer: BC

403. <Huawei>reset saved-configuration

Warning: The action will delete the saved configuration in the device.

The configuration, will be erased to reconfi gure. Continue? [Y/N]:

The administrator configured the above on the AR2200, and which of the following description about the configuration information is correct?

- A. The saved configuration file will be replaced by the running configuration file.
- B. If the user wants to clear the saved configuration file, he should select "Y" (Right Answers)
- C. If the user wants to clear the saved configuration file, he should select "N"
- D. The configuration file will be retained when the device starts up.

Answer: B

404. On the VRP interface, use the command startup saved-configuration backup.ofg to configure the backup.cfg file for the next startup.

- A. True (Right Answers)
- B. False

Answer: A

405. Which of the following states is the STP port converted between exist Forward Delay? (Multiple choice)

- A. Forwarding-Disabled
- B. Blocking-Listening
- C. Disabled-Blocking
- D. Listening-Learning (Right Answers)
- E. Learning-Forwarding (Right Answers)

Answer: DE

406. Which of the following parameters should be considered when electing a root port in STP? (Multiple choice)

- A. Duplex mode of the port
- B. Port slot number, such as GO/0/1
- C. Port MAC address (Right Answers)
- D. Port priority (Right Answers)
- E. the cost of the port reaches the root switch (Right Answers)

Answer: CDE

407. Which of the following port states does not the RSTP protocol include?

- A. Blocking (Right Answers)
- B. Forwarding
- C. Discarding
- D. Learning

Answer: A

408. Which router is the BDR in this network, as shown in the figure below?

- A. Router B
- B. Router A
- C. no BDR (Right Answers)
- D. Router C

Answer: C

409. It is known that the routing table of a router has the following two entries:

If the router wants to forward a message with a destination address of 9.1.4.5, which of the following statement is correct?

- A. Select the second item as the best match because Ethernet is faster than Serialo
- B. Select the first item as the best match because the OSPF protocol has a higher priority value.
- G. Select the second item as the best match because the RIP protocol has a lower generation value.
- D. Select the second term as the best match because the route is a mare accurate match than the destination address of 9.1.4.5 (Right Answers)

Answer: D

410. The following is the routing table of router R1. If R1 sends a packet with the destination IP address of 10.0.2.2, which interface does it need to send from?

- A. Ethernet0/0/2
- B. Ethernet0/0/1 (Right Answers)
- C. Ethernet0/0/0
- D. GigabitEthernet0/0/0

Answer: B

411. When routers are running in the same OSPF area, which of the following description of their LSDB and routing table is correct? (Multiple choice)
- A. The link state database obtained by each router is different.
 - B. The routing table of each router is different. (Right Answers)
 - C. The link state database obtained by all routers is the same (Right Answers)
 - D. The routing tables obtained by all routers are the same.

Answer: BC

412. Which of the following elements are included in the routing table? (Multiple choice)

- A. Interface (Right Answers)
- B. Protocol (Right Answers)
- C. Destination/Mask (Right Answers)
- D. Cost (Right Answers)
- E. NextHop (Right Answers)

Answer: ABCDE

413. The output information of a router routing table is as follows. Which of the following statement is correct? (Multiple choice)

- A. The NextHop of this router reaching 10.0.0.1 is 10.0.21.2.
- B. The NextHop of this router reaching 10.0.2.2 is 10.0.21.2. (Right Answers)
- C. The NextHop of this router reaching 10.0.0.1 is 10.0.12.2. (Right Answers)
- D. The NextHop of this router reaching 10.0.2.2 is 10.0.12.2.

Answer; BC

414. By default, how long is the lease time of the IP address assigned by the DHCP server?

- A. 1 h
- B. 24h (Right Answers)
- C. 12h
- D. 18h

Answer: B

415. Which of the following applications is based on the TCP protocol? (Multiple choice)

- A. FTP (Right Answers)
- B. HTTP (Right Answers)
- C. Ping
- D. TFTP

Answer: AB

416 The DHCP server function is enabled on an interface of the router. Which of the following IP addresses may the DHCP client obtain?
interface GigabitEthernet0/0/1
ip address 11 0 1 1 255 255.255.0
dhcp select interface
dhcp server excluded-ip-address 11 0 1 2 11 0 1.127

- A 11 0 1 1
- B. 11.0.1.100
- C 11.0.1 254 (Right Answers)
- D. 11.0.1.255

Answer: C

417. On the switch, which VLANs can be deleted by using the undo command? (Multiple choice)

- A. v[an 4094 (Right Answers)
- B. vian 1
- C. vlan 2 (Right Answers)
- D. elan 1024 (Right Answers)

Answer: AGD

418 In the network shown in the following figure, the output information of switch A is as follows. In the current MAC address table of itch A, which interlace dues the C address of host B correspond to'

- A GigabitEthernet0/0/2
- B. Eth-Trunk 1 (Right Answers)
- C GigabitEthemet0/0/1
- B. GigabitEthemet0/0/3

Answer: B

419. As shown in the following figure, the router configuration information is as follows. Which of the following statement is correct?

Router A interface GigabitEthernet0/0/0.100

dot1q termination vid 200

ip address 10.0.12.1 255.255.255.0

arp broadcast enable

Router B

interface GigabitEthernet0/0/0.200

dot1q termination vid 200

ip address 10.0.12.2 255.255.255.0

arp broadcast enable

- A. 10.0.12.1 can ping 10.0.12.2 (Right Answers)
- B. The sub-interface of Router A cannot learn the MAC address of the sub-interface of Router B.
- C. The sub-interface of Router B cannot learn the MAC address of the sub-interface of Router A.
- D. Router A and Router B cannot communicate because the sub-interface numbers of Router A and Router B are inconsistent.

Answer: A

420. Which of the following parameters does the LCP negotiation use to detect link loops and other anomalies?

- A. CHAP
- B. MRU
- C. PAP
- D. Magic word (Right Answers)

Answer; D

421. Static NAT can only implement one-to-one mapping between private addresses and public addresses.

- A. True (Right Answers)
- B. False

Answer: A

422. Which of the following does AAA not include?

- A. Accounting
- B. Authorization
- C. Audit (Right Answers)
- D. Authentication

Answer: C

423. Which authorization modes does W support on Huawei ARG3 series routers? (Multiple choice)

- A. HWTACACS authorization **(Right Answers)**
- B. Nat authorized **(Right Answers)**
- C. Authorization after successful RADIUS authentication **(Right Answers)**
- D. Local authorization **(Right Answers)**

Answer: ABCD

424. Which of the following about the function of the AH protocol in IPsec VPN is wrong?

- A. Support data integrity check
- B. Support anti-message playback
- C. Support packet encryption **(Right Answers)**
- D. Support data source verification

Answer: C

425 As shown in the following figure, the router functions as the DHCPv6 relay agent and Router B functions as the DHCPv6 server. Which of the following parameters must be configured on Router B? (Multiple choice)

- A. Enable RA on port G0/0/1 of Router B
- B. IPv6 address of the DHCPv6 relay
- C. DHCPv6 DUID **(Right Answers)**
- D. DHCPv6 address pool **(Right Answers)**

Answer: CD

426. How many times is the total length of an IPv6 address the length of an IPv4 address?

- A. 4 **(Right Answers)**
- B. 3
- C. 5
- D. 2

Answer: A

427. Which of the following extended headers are supported by IPv6 packets? (Multiple choice)

- A. VLAN extension header
- B. hop-by-hop option extension header **(Right Answers)**
- C. Destination option extension header **(Right Answers)**
- D. Slice extension header **(Right Answers)**

Answer: BCD

428. Which packet does the DHCPv6 server use to reply to Solicit packets?

- A. Request
- B. Advertise **(Right Answers)**
- C. Offer
- D. Reply

Answer: B

429. The MPLS architecture consists of a Control Plane and a Forwarding Plane. The forwarding plane mainly performs label switching and packet forwarding.

- A. True **(Right Answers)**
- B. False

Answer: A

430. What is the length of the Ethernet_II frame that contains the Ethernet header?

- A. 64-15188 **(Right Answers)**
- B. 60-1560B
- C. 64-1500B
- D. 46-1500B

Answer: A

431. The Tracert diagnostic tool in Huawei routers uses UDP to encapsulate trace data.

- A. True **(Right Answers)**
- B. False

Answer: A

432. The broadcast address of the subnet 192.168.1.0/25 is 192.168.1.128.

- A. True
- B. False **(Right Answers)**

Answer: B

433. Which memory saved configuration is used to select VRP version file when the device starts up?

- A. NVRAM **(Right Answers)**
- B. SD Card
- C. Flash
- D. USB

Answer: A

434. Which of the following parameter settings for terminal emulation are correct when configuring a router through the Console port?
- A. 9600bps, 8 data bits, 1 stop bits, even parity check, and hardware flow control.
 - B. 19200bps, 8 data bits, 1 stop bits, no parity check, and no flow control.
 - C. 4800bps, 8 data bits, 1 stop bits, odd parity check, and no flow control.
 - D. 9600bps, 8 data bits, 1 stop bits, no parity check, and no flow control. **(Right Answers)**

Answer: D

435. Which layer of the OSI reference model does the switch work on?
- A. Network layer
 - B. Transport layer
 - C. Data link layer **(Right Answers)**
 - D. Physical layer

Answer: C

436. Which of the following statements about the Alternate port in the RSTP protocol is correct?
- A. The Alternate port serves as a backup for the specified port and provides another backup path from the root bridge to the corresponding network segment.
 - B. Alternate port forwards user traffic and learns MAC address
 - C. Alternate port does not forward user traffic but learns MAC address
 - D. Alternate port provides another switchable path from the designated bridge to the root as the backup port of the root port **(Right Answers)**

Answer: D

437. Which of the following port states does the RSTP protocol not include?
- A. Discarding
 - B. Blocking **(Right Answers)**
 - C. Learning
 - D. Forwarding

Answer: B

438. In the RSTP standard, in order to improve the convergence speed, the port directly connected to the terminal by the switch can be defined as 0.
- A. Fast port
 - B. Root port
 - C. Edge port **(Right Answers)**
 - D. Backup port

Answer: C

439. VRP operating platform, which of the following commands can only view static routes?
- A. display ip routing-table verbose
 - B. display ip routing-table statistics
 - C. display ip routing-table protocol static **(Right Answers)**
 - D. display ip routing-table

Answer: C

440. Which layer of the OSE reference model does the router work on?

- A. Data link layer
- B. Network layer **(Right Answers)**
- C. Application layer
- D. Transport layer

Answer: B

441. Which of the following description of static and dynamic routing is wrong?

- A. Dynamic routing protocols take up more system resources than static routes
- B. Static routing is simple to configure and easy to manage when applied in an enterprise.
- C. After a link fails, static routes can automatically complete network convergence. **(Right Answers)**
- D. After administrators deploy dynamic routing protocols in the enterprise network, post-maintenance and expansion can be more convenient.

Answer; C

442. Which of the following features does the OSPF protocol have?

- A. Easy to generate routing loops
- B. Calculate the shortest path in hops
- C. Supporting the division of regions **(Right Answers)**
- D. Poor scalability

Answer: C

443. A router runs OSPF and does not specify a router ID. The P address of all interfaces is as follows. What is the router ID of the router OSPF protocol?

- A. 10.0.12.1
- B. 10.0.1.2 **(Right Answers)**
- C. 10.0.21.1
- D. 10.0.1.1

Answer: B

444. What port number is used by the FTP protocol to control plane?

- A. 22
- B. 21 **(Right Answers)**
- C. 24
- D. 23

Answer: B

445_ An administrator cannot log in to the AR22013 router through Telnet. However, other administrators can log in normally. Which of the following are possible causes? (Multiple choice)

- A. The admin user account has been deleted **(Right Answers)**
- B. The admin user account has been disabled **(Right Answers)**
- C. The privilege level of the admin user account has been modified to 0
- D. The Telnet service of the AR2200 router has been disabled.

Answer: AB

446 The Eth-Trunk port in manual link aggregation mode, whose transmission rate is related to 0 (Multiple choice)

- A. Bandwidth of member ports **(Right Answers)**
- B. Is the member port on the public or private network?
- C. Is the IP address configured on the member port?
- D. Number of member ports **(Right Answers)**

Answer: AD

447. As shown in the following figure, the ports connected to the host of Switch A and Switch B belong to VLAN 10 and VLAN 20 respectively. The port A on the switch is Trunk and the PVID is 10. Which of the following statements are correct? (Multiple choice)

- A. Host A and host B can communicate via VLAN 10 and cannot ping each other.
- B. Host A and host B can ping. **(Right Answers)**
- C. Host A's ARP request is forwarded to host B.
- D. The switch does not carry as VLAN 10 TAG when forwarding data frames sent by the host. **(Right Answer.)**

Answer: BD

448 The authentication scheme, authorization scheme, accounting scheme, HWTACACS, or RADIUS server template created on the AR router can take effect only after it is applied in the domain.

- A. True **(Right Answers)**
- B. False

Answer: A

449. The router can assign a specified IP address to the host through a stateless address autoconfiguration scheme.

- A. True
- B. False **(Right Answers)**

Answer: B

450_ Which multicast address is used in OSPFv3 to represent all routers?

- A. FF02::6
- B. FF02::8
- C. FF02::5 **(Right Answers)**
- D. FF02::1

Answer: C

451_ The OSPFv3 adjacency can be established only after the IP& address prefixes of the two ends are the same.

- A. True
- B. False **(Right Answers)**

Answer: B

452. Which of the following IPv6 addresses has a Solicited-node multicast address of FF02::1 :FF12:12

- A. 2020::1200:1
- B. 2019::12:1 **(Right Answers)**
- C. 201g:112:1000
- D. a 2020:112AB11

Answer: B

453. Which of the following statements about the Adjacency Segment is wrong?

- A. Adjacency Segment is used to identify a certain adjacency of a node in the network_
- B. Adjacency Segment is identified by Adjacency Segment ID (STD)
- C. Adjacency Segment spreads to other network elements through the IGP protocol, which is globally visible and valid locally.
- D. Adjacency Segment must be manually configured **(Right Answers)**

Answer:

454. What levels are not included in the TCP/IPv4 model? (Multiple choice)

- A. Session layer **(Right Answers)**
- B. Presentation layer **(Right Answers)**
- C. Network layer
- D. Transport layer
- E. Application layer

Answer: AB

455. In the OSI reference model, which of the following has the ability to perform end-to-end error detection and flow control?

- A. Physical layer
- B. Data link layer
- C. Network layer
- D. Transport layer **(Right Answers)**

Answer:

456 As shown in the figure, after the network administrator completes the Telnet configuration on the router, it is found that the host cannot establish a connection with the router through Telnet. Which of the following options can help solve this problem? (Multiple choice)

- A. Check if the switch has a default gateway address configured.
- B. Use Ping to check the IP connectivity between the host and the router G0/0/0 interface **(Right Answers)**
- C. Check if the Telnet configuration on the router is correct **(Right Answers)**
- D. Check if the host's ARP cache table overflows

Answer: BC

457. After receiving the BREW set by the TC, the switch running the RSTP protocol clears the MAC address learned by all ports.

- A. True
- B. False (Right Answers)

Answer: B

458. In the RSTP protocol, when the topology is stable, which port roles are in the Discarding state? (Multiple choice)

- A. Backup part (Right Answers)
- B. Designated part
- C. Alternate port (Right Answers)
- D. Root port

Answer: AC

459. Which of the following statement about STP messages is correct? (Multiple choice)

- A. During the initialization process, each switch that enables STP protocol actively sends configuration BPDUs. (Right Answers)
- B. When the port is enabled with STP, the switch periodically sends TCN BPDUs from the specified port.
- C. The BPDU packet is encapsulated in an Ethernet data frame, and the destination MAC address is a multicast MAC address. (Right Answers)
- D. There are two types of packets in the STP protocol, configuration BPDUs and TCN BPDUs. (Right Answers)

Answer: ACD

460. What is the value of the Type field in the RSTP configuration BPDUs?

- A. 0x01
- B. 0x03
- C. 0x00
- D. 0x02 (Right Answers)

Answer: D

461. Which of the following cases will the switch running RSTP generate a configuration BPDU with TO set?

- A. A non-edge port migrates to the Forwarding state (Right Answers)
- B. Backup port down
- C. Edge port migrates to Forwarding state
- D. Edge port migrates to Discarding state

Answer: A

462. Which of the following routing protocols can generate a default route? (Multiple choice)

- A. OSPFv3 (Right Answers)
- B. Direct
- C. OSPF (Right Answers)
- D. Static (Right Answers)

Answer: ACD

463. The router running OSPF first reaches the FULL state, and then performs LSDB synchronization.

- A. True
- B. False **(Right Answers)**

Answer: B

464. As the network shown in the following figure, all routers run OSPF. The top of the link is the value of the Cost. What is the path of the RA to the network 10.0.0.8/8?

- 0A. 70
- 0B. 100
- 0C. 60 **(Right Answers)**
- 0D. 20

Answer: C

465. Which packet does OSPF use to acknowledge received LSU packets?

- A. LSACK **(Right Answers)**
- B. LSA
- C. LSR
- D. LSU

Answer: A

466 if the Proto of a routing information in the routing table is OSPF, the priority of this route must be 10.

- A. True
- B. False **(Right Answers)**

Answer: B

467. On the serial interface, you can configure a static route by specifying the next hop address or outbound interface.

- A. True **(Right Answers)**
- B. False

Answer: A

468 If the network shown in the following figure is used to make the top-to-bottom communication between Router A and Router B through static routes, which of the following commands need to be entered on Router A?

- A. `ip route-static 1002 2 32 GigabitEthernet 0/0/0`
- B. `ip route-static 1002 2 255.255.255.255 100 12 1`
- C. `ip route-static 1002 2 255.255.255.255 10.0.12 2` (Right Answers)
- D. `ip route-static 1002 20 GigabitEthernet 0/0/0`

Answer: C

469. TFTP is based on the TCP protocol.

- A. True
- B. False (Right Answers)

Answer: B

470. The output information of a switch is as follows. Which of the following statements is correct? (Multiple choice)

- A. The user manually created 4 VLANs. (Right Answers)
- B. When the GE0/0/1 port of the switch sends the data frame of VLAN 10, it does not carry the VLAN TAG. (Right Answers)
- C. When the GE0/0/2 port of the switch sends the data frame of VLAN 20, it carries the VLAN TAG.
- D. When the GE0/0/1 port of the switch sends the data frame of VLAN 20, it does not carry the VLAN TAG.

Answer: AB

471. A trunk port and a Hybrid port are handled in the same way when receiving data frames.

- A. True (Right Answers)
- B. False

Answer: A

472. Which of the following PPPoE messages are sent non-unicast?

- A. PADS
- B. PADI **(Right Answers)**
- C. PADO
- D. PADR

Answer: B

473. Which of the following fields does the HDLC frame consist of? (Multiple choice)

- A. Control field (C) **(Right Answers)**
- B. Frame Check Sequence Field (FCS) **(Right Answers)**
- C. Address field (A) **(Right Answers)**
- D. Flag field (F) **(Right Answers)**

Answer: ABCD

474. The following figure shows the encapsulation format of the data packet in IPsec VPN. Which format is the type of data packet used to encapsulate in IPsec V1417

- A. Tunnel mode **(Right Answers)**
- B. Universal mode
- C. Transmission mode
- D. This encapsulation is error

Answer: A

475. Which of the following SNMP messages is sent to the NMS by the agent on the managed device?

- A. Get-Next-Request
- B. Get-Request
- C. Set-Request
- D. Response **(Right Answers)**

Answer: D

476. The ACL does not filter the traffic that the device itself generates to access other devices. Only the forwarded traffic is filtered. The forwarded traffic includes traffic that other devices access the device.

- A. True **(Right Answers)**
- B. False

Answer: A

477. What is the number range of the Layer 2 ACL?

- A. 4000-4999 **(Right Answers)**
- B. 6000-6031
- C. 2000-2999
- D. 3000-3999

Answer: A

478. Which of the following statement about ipv6 address configuration is correct? (Multiple choice)

- A. IPv6 address supports multiple ways of automatic configuration **(Right Answers)**
- B. IPv6 supports DHCPv6 format for address configuration **(Right Answers)**
- C. IPv6 addresses can only be manually configured.
- D. IPv6 supports stateless autoconfiguration **(Right Answers)**

Answer: ABD

479. The OSPFv3 protocol itself does not provide authentication.

- A. True **(Right Answers)**
- B. False

Answer: A

480. The Flow Label Field, Source Address Field, and Destination Address field in IPv6 together specify a forwarding path in the network for a particular data stream.

- A. True **(Right Answers)**
- B. False

Answer: A

481. Which of the following IPv6 addresses is a multicast address?

- A. FF02::2E0: FCFF: FEEF: FEC **(Right Answers)**
- B. FE80::2E0: FCFF: FEEF: FEC
- C. 2000::2E0: FCFF: FEEF: FEC
- D. FC00::2E0: FCFF: FEEF: FEC

Answer: A

482. Which technology does the shared medium network use for data forwarding?

- A. CDMA/CD **(Right Answers)**
- B. CSMA/CD
- C. TDMA/CD
- D. CSMA/1CD

Answer: A

483. Which of the following IPv4 addresses is a Class A address?

- A. 100.1.1.1
- B. 172.16.1.1
- C. 121.1.1.1 **(Right Answers)**
- D. 192.168.1.1

Answer: C

484. How many ways does VRP support to configure router? (Multiple choice)

- A. Configure the router through Telnet **(Right Answers)**
- B. Configure the router through FTP
- C. Configure the router through the mini USB port **(Right Answers)**
- D. Configure the router through the console port. **(Right Answers)**

Answer: ACD

485.

The above is the display startup information of the AR2200 router. For this information, which of the following statements is wrong?

- A. The running configuration file is not saved
- B. The system file used for starting the device is ar22204200r003c0Ospc200.cc
- C. The system file of the next startup of the device can be modified by using the command "startup system software <atartup-software-name>".
- D. The system file cannot be modified when the device starts next time. **(Right Answers)**

Answer: D

486. In the VRP system, which of the following functions does the Ctrl +Z combination key have? (Multiple choice)

- A. Exit the console interface view.
- B. Return to the user view from the system view **(Right Answers)**
- C. Exit interface view
- D. Return to the user view from arty view **(Right Answers)**
- E. Exit the current view

Answer: BD

487. Which of the following description of the Forwarding state in the spanning tree protocol is wrong?

- A. port in Forwarding state can send BPDUs.
- B. port in Forwarding state does not learn the source MAC address of the packet. **(Right Answers)**
- C. port in Forwarding state can forward data packets
- D. port in Forwarding state can receive BPDUs.

Answer: B

488. The bridge ID of the STP protocol in the switching network is as follows. Which of the following bridge ID owned by switch will become the root bridge?

- A. 32768 00-01-02-03-04-AA
- B. 32768 00-01-02-03-04-BB
- C. 32768 00-01-02-03-04-CC
- D. 4096 00-01-02-03-04-DD **(Right Answers)**

Answer: D

489. The RSTP protocol uses the PIA mechanism to speed up the speed at which the upstream port goes to the Forwarding state, but the loop is not available, what is the reason?
- A. Introduced edge ports
 - B. Shortened the time of Forward Delay
 - C. Ensure that loops do not occur by blocking its own non-root ports (Right Answers)
 - D. Speed up the port role election

Answer: C

490. Which of the following statement about the dynamic MAC address table is correct? (Multiple choice)
- A. The interface learns by using the source MAC address in the packet. The entry can be aged. (Right Answers)
 - B. Dynamic entries are lost after system reset, hot swappable interface board, or interface board reset
 - C. can obtain the number of users communicating on the interface by viewing the number of dynamic MAC address entries. (Right Answers)
 - D. The saved entries are not lost after the system reset, hot swappable interface board, or interface board reset. (Right Answers)

Answer, ACD

491. Which of the following protocols is dynamic IGP routing protocol?

- A. Static
- B. BGP
- C. OSPF (Right Answers)
- D. Direct

Answer: C

492. The router needs to modify the destination IP address in the data packet when forwarding the data packet.

- A. True
- B. False (Right Answers)

Answer: B

493. route-static 10.0.2.2 255.255.255.255 10.0.12.2 preference 20, which of the following statement about this command is correct?

- A. The route must appear in the routing table.
- B. The destination network of the route is 10.0.12.2/32
- C. The priority of this route is 100.
- D. The mask length of the route destination network is 32 bits. (Right Answers)

Answer:

494. Which of the following statement about the OSPF protocol DR is correct?

- A. DR must be the highest priority device in the network
- B. DR election is preemptive
- C. Router ID. The larger the value, the higher the priority is elected as DR.
- D. An interface priority is 0, and then the interface cannot be a DR (Right Answers)

Answer: D

495_ Which of the following statement about the priority of static routes in Huawei devices is incorrect?

- A. The default value of static route priority is 60.
- B. The priority value of the static route is 255, indicating that the route is unavailable.
- C. The static route priority value ranges from 0 to 255. (Right Answers)
- D. The priority of static routes is divided into internal priority and external priority. Administrators can modify external priority

Answer: C

496_ The router starts the FTP service_ The username and password are both huawei, and the root directory of the FTP is set to flash/dhcp/. Which of the following commands must be configured? (Multiple choice)

- A. local-user huawei password cipher huawei (Right Answers)
- B. ftp server enable (Right Answers)
- C. local-user huawei service-type ftp (Right Answers)
- D. local-user huawei ftp-directory flash/dhcp/ (Right Answers)

Answer: ABCD

497 The priority of the LACP protocol is as shown in the figure. Switch A and Switch B adopt link aggregation in LACP mode, and all interfaces join the link aggregation group. The maximum number of active ports is set to 3. Which port of switch A is not the active port?

- A. G0/0/2
- B. G0/0/3 (Right Answers)
- C. G0/0/0
- D. G0/0/1

Answer: B

498. If an Ethernet data frame has LengthType=0x8100, which of the following statement is correct?

- A. This data frame must carry VLAN TAG (Right Answers)
- B. The TCP header must exist in the upper layer of this data frame.
- C. The UDP header must exist in the upper layer of this data frame.
- D. The IP header must exist in the upper layer of this data frame.

Answer: A

499. Which of the following description about the trunk port and the Access port is correct?

- A. The Trunk port can only send tagged frames.
- B. The Trunk port can only send untagged frames.
- C. The Access port can only send tagged frames.
- D. The Access port can only send untagged frames. (Right Answers)

Answer: D

500 As shown in the following figure, Switch A and Router A are connected through two links. The two links are in the manual load balancing mode. The administrator sets the priority of the aggregation link to 1, and the data is forwarded through the aggregation link which needs to carry VLAN TAG 100, which configuration does Router A need to use? (Multiple choice)

a

- A. interface Eth-Trunk1 port-tunnel protocol vlan 100 interface GigabitEthernet0/24 eth-trunk 1
- B. interface Eth-Trunk1 undo port-tunnel protocol vlan 100 address 10.0.12.225 255.255.0 arp broadcast enable (Right Answers)
- C. interface Eth-Trunk1 mode lacp-mode active (port-tunnel protocol vlan 100 interface GigabitEthernet0/24 eth-trunk 1 undo lacp mode active)
- D. interface Eth-Trunk1 mode lacp-mode active (port-tunnel protocol vlan 100 interface GigabitEthernet0/24 eth-trunk 1 undo lacp mode active)

Answer: BB

501_ Which of the following functions are supported by the LCP protocol in the PPP protocol? (Multiple choice)

- A. Negotiate the maximum receiving unit **MRU (Right Answers)**
- B. Negotiate the authentication protocol **(Right Answers)**
- C. Negotiate the network layer address
- D. Detect link loops **(Right Answers)**

Answer: ABD

502 A company has 50 private IP addresses. The administrator uses NAT technology to connect the company network to the public network. However, the company has only one public network address. Which of the following NAT conversion methods meets the requirements?

- A. easy-ip **(Right Answers)**
- B. NAT
- C. Dynamic conversion
- D. Static conversion

Answer: A

503 As shown in the figure, there is a Web server in the private network that needs to provide HTTP services to public network users. Therefore, the network administrator needs to configure NAT on the gateway router RTA to implement the requirements. Which of the following configuration can meet the requirements?

- A. `[RTA-Serml1/0/1]nat server protocol tcp global 202.101.www inside 192.168.1.1 8080` **(Right Answers)**
- B. `[RTA-Serml1/0/1]na1 server protocol tcp global 192.168.1.1 www inside 20210_101 8080`
- C. `[RTA-Gmabithernet10/0/1]nat server protocol tcp global 20210.101.www inside 192.168.1.1 8080`
- D. `E1_[RTA-Gmabithernet10/0/1]nat server protocol tcp global 192.168_11.www inside 20210101 8080`

Answer: A

504 When deploying an ACL on a Huawei device, which of the following description is correct? (Multiple choice)

- A. When ACLs define rules, they can only be advanced in the order of 10, 20, and 30
- B. The same ACL can be called under multiple interfaces **(Right Answers)**
- C. Can only be applied to the outbound direction when the ACL is called on the interface.
- D. ACLs cannot be used to filter OSPF traffic because OSPF traffic is not encapsulated using UDP protocol.
- E. The ACL can match the TGP/UDP port number of the packet, and can specify the range of the port number. **(Right Answers)**

Answer: BE

505. Which of the following message types does RADIUS use to indicate authentication rejection?

- A. Access-Reject **(Right Answers)**
- B. Access-Request
- C. Access-Challenge
- D. Access-Accept

Answer: A

506. Which authentication modes does AAA support on Huawei AR G3 series routers? (Multiple choice)

- A. 802.1x
- B. None **(Right Answers)**
- C. HWTACACS **(Right Answers)**
- D. Local **(Right Answers)**

Answer: BCD

507 if the maximum number in the ACL rule is 12, by default, when the user configures a new rule without specifying a number, what is the number assigned in the new rule by the system?

- A. 14
- B. 16
- C. 15 **(Right Answers)**
- D. 13

Answer: C

508. If two IPsec VPN peers want to use both AH and ESP to ensure secure communication, how many SAs (Security Associations) do the two peers need to build?

- A. 1
- B. 2
- C. 3
- D. 4 (Right Answers)

Answer: D

509. DHCPv6 belongs to a stateful address autoconfiguration protocol.

- A. True (Right Answers)
- B. False

Answer: A

510. The DHCPv6 server includes the management address configuration flag (M) in the RA message. If the value is 1, which of the following statement is correct?

- A. Indicates that the client enables DHCPv6 stateful address configuration. (Right Answers)
- B. Indicates that the client needs to obtain other network configuration parameters through stateless DHCPv6.
- C. Indicates that the client enables IPv6 stateless address automatic allocation scheme
- D. Indicates that the client needs to obtain other network configuration parameters through stateful DHCPv6.

Answer: A

511. In the OSI reference model, which of the following has the ability to perform end-to-end error detection and flow control?

- A. Transport layer (Right Answers)
- B. Network layer
- C. Data link layer
- D. Physical layer

Answer: A

512. After application data is processed through the data link layer, what does it call?

- A. Segment
- B. PDU
- C. Frame (Right Answers)
- D. Packet

Answer: C

513.<Huawei>system-view

[Huawei] user-interface console 0

[Huawei-ui-console0] history-command max-size 20

Regarding the above configuration, which of the following statement is correct?

- A. history-command max-size 20 is to adjust the size of the history command cache to 20 (Right Answers)
- B. The default size of the history command cache is 5
- C. The default size of the history command cache is 5 bytes.
- D. After the above configuration is completed, the history command cache can save 20 bytes of commands.

Answer: A

514. What is the destination MAC address of the BPDU in the STP protocol?

- A. 01-80-C2-04-05-06
- B. FF-FF-FF-FF-FF-FF
- C. 00-80-C2-00-00-00
- D. 01-80-C2-00-00-00 (Right Answers)

Answer: D

515. As shown in the figure, if the switch runs STP with default parameters, which of the following ports will be elected as the designated port?

EI

- A. G0/0/1 port of Switch A (Right Answers)
- B. G0/0/2 port of switch A
- C. HUB's E0/0/2 port
- D. HUB's E0/0/1 port

Answer: A

516. The router has the longest matching principle when looking up the routing table. Which of the following parameter is the length?

- A. The size of the NextHopIP address
- B. Priority of the routing protocol
- C. Cost
- D. The length of the mask (Right Answers)

Answer: D

517. Which packet does OSPF use to describe its own LSDB?

- A. LSR
- B. HELLO
- C. DD (Right Answers)
- D. LSU

Answer: C

518. HhaweiGigabitEthernet0/011] port link-type access

[Huawei-GigabitEthernet0/0/1] port default vlan 10

[Huawei-GigabitEthernet0/0/2] port link-type trunk

[Huawei-GigabitEthernet0/012] port trunk allow-pass vlan 10

According to the command shown above, which of the following descriptions is correct? (Multiple choice)

- A. The PVID of GigabitEthernet0/0/2 port is 1. (Right Answers)
- B. The PVID of GigabitEthernet010/2 port is 10
- C. The PVID of GigabitEthernet0/0/1 port is 1.
- D. The PVID of GigabitEthernet0/0/1 port is 10. (Right Answers)

Answer: AD

519 As shown in the following diagram, two switches are connected through four links. COPPER refers to Ethernet interfaces, and FISH refers to the optical interface. Which of the following link aggregation methods can be implemented on the optical interface?

- A LACP mode
- B EtherChannel mode
- C LACP mode
- D EtherChannel mode

Answer: C

520 If a network administrator wants to divide users who frequently change office locations and often access different networks from the company to be connected to MANIC, which of the following methods should be used to divide VLANs?

- A Divide MAN based on protocol
- B Divide VLAN based on MAC address (Right Answers)
- C Divide VLAN based on Port
- D Divide WAN based on VLANs

Answer: B

521. Which two stages can the PPPoE session establishment process be divided into? (Multiple choice)

- A. PPP connecting stage
- B. Discovery stage (Right Answers)
- C. PPPoE Session stage (Right Answers)
- D. DHCP stage

Answer: BC

522 IOTA] aaa

```
RTA-aaa domain Huawei  
[RTA-aaa domain-Huawei] authentication-scheme au1  
[RTA-aaa domain-Huawei] authentication-scheme au2
```

The network administrator performs the above configuration on the Huawei router RTA. If a user needs to be authenticated in the authentication domain "Huawei", which of the following descriptions is correct?

- A Will use "authentication-scheme au1" authentication, if "au1" is deleted, "au2" authentication will be used
- B Will use "authentication-scheme au2" authentication, if "au2" is deleted, "au1" authentication will be used
- C Will use the "authentication-scheme 002" authentication (Right Answers)
- D Will use the "authentication-scheme out" authentication

Answer: C

523. Huawei ARG3 series routers enable all versions of SNMP (SNMPv1, SNMPv2c, and SNMPv3) by default.

- A. True (Right Answers)
- B. False

Answer: A

524. Which of the following encapsulation modes does IPsec VPN support? (Multiple choice)

- A. Tunnel mode (Right Answers)
- B. Exchange mode
- C. Transmission mode (Right Answers)
- D. Routing mode

Answer: AC

525 Two authentication domains "Area 1" and "Area 2" are configured on a router. The server serves as the authentication server. The correct username and password are "user1" and "password1". Which of the following authentication methods is correct?

- A Authentication domain "Area1"
- B Authentication domain "Area2"
- C Authentication domain "default_admin domain"
- D Authentication domain "default domain" (Right Answers)

Answer: C

526. If the EUI-64 address 78BC-FEFF-FFFE-EFAB is calculated based on the MAC address, what should its corresponding MAC address be?

- A. 7ABC-FEFE-EFAB (Right Answers)
- B. 78BC-FFFE-EFAB
- C. 7ABC-FFFE-EFAB
- D. 78BC-FEFE-EFAB

Answer: A

527. The DHCPv6 client must obtain both IPv6 addresses and another configuration information from the DHCPv6 server.

- A. True
- B. False (Right Answers)

Answer: B

528. When the network device sends the IPv6 packet, the packet length is compared with the MTU value. If the value is greater than the MTU value, the packet is directly discarded.

- A. True
- B. False (Right Answers)

Answer: B

529. The output information of the router interface is as follows. Which multicast address data can the interface receive? (Multiple choice)

- A. FF02::2 (Right Answers)
- B. FF02::1: FF12:1 (Right Answers)
- C. FF02::1: FF6FAF36 (Right Answers)
- D. FF02::1 (Right Answers)

Answer: ABCD

530. Which of the following statement about the IPv6 anycast address is correct? (Multiple choice)

- A. The packet whose destination address is anycast address will be sent to the network interface in the meaning of the route. (Right Answers)
- B. Implement load sharing of services (Right Answers)
- C. Provide redundancy for services (Right Answers)
- D. Anycast address and unicast address use the same address space (Right Answers)

Answer: ABCD

531. The MPLS label header is encapsulated between the data link layer header and the network layer header of the message.

- A. True (Right Answers)
- B. False

Answer: A

532. When using the Traced program to test the path through which the target node passes, the default TTL value for Traceroute is measured 0 times.

- A.3 (Right Answers)
- fr 8
- fr 6
- D.4

Answer: A

533. Which of the following description of the role of the free ARP message is wrong?

- A Used to advertise the active/standby switchover in the VRRP backup group.
- B Used to advertise a new current AC address. The sender replaces the NIC and the AC address changes. In order to notify all hosts before the AP entry ages, the sender can send a free ARP.
- G Used to check duplicate IP addresses. Normally, no ARP response will be received. If received, it indicates that there is an address in the network that is duplicated with its own IP address.
- O Free ARP packets are used to keep active with the gateway device when the host is idle. (Right Answers)

Answer: 0

534. Which of the following statement about the ARP message is wrong?

- A. The ARP reply message is sent by the unicast party.
- B. Any network device needs to obtain the data link layer identifier by sending ARP packets. (Right Answers)
- C. ARP request message is sent by broadcast
- ID ARP packets cannot traverse the router and cannot be forwarded to other broadcast domains.

Answer: B

535. Using the command mkdir test in the VRP operating platform, the system will create a folder named test.

- A. True (Right Answers)
- B. False

Answer: A

536 When the switch receives a unicast data frame, it will look up the destination MAC address in the MAC table. Which of the following statement is wrong?

- A. If the MAC address is found, and the corresponding port of the MAC address in the MAC address table is not the one that enters the switch, the switch performs the forwarding operation
- B. If the MAC address is found, and the corresponding port of the MAC address in the MAC address table is the port that the frame enters the switch, the switch performs the discard operation
- C. If the MAC address is not found, the switch performs the flooding operation.
- D. If the MAC address is not found, the switch performs the discard operation. (Right Answers)

Answer: 0

537. The default route can be derived from (). (Multiple choice)

- A Manua[configuration (Right Answers)
- B. Dynamic routing protccof generation (Right Answers)
- G. The router itself has
- a Link layer protocol generation

Answer: AB

538. Which of the following packets belong to the OSPF protocol? (Multiple choice)

- A. LSU **(Right Answers)**
- B. LSA
- C. LSR **(Right Answers)**
- D. HELLO **(Right Answers)**

Answer: ACD

539. On the broadcast network, both the DR and the BDR use the multicast address 224.0.0.6 to receive the link status update packet.

- A. True **(Right Answers)**
- B. False

Answer: A

540. As shown in the following figure, all routers run OSPF. Which device is ABR? (Multiple choice)

- A. Router **B (Right Answers)**
- B. Router **D**
- C. Router C
- D. Router **A (Right Answers)**

Answer: AD

541. The output information of a switch is as follows. Which of the following interfaces can forward data frames with a VLAN ID of 40 and does not carry labels when forwarding?

- A. GEO/0/4
- B. GEO/0/2
- C. GEO/0/3
- D. GEO/0/5 (Right Answers)

Answer: D

542. As shown in the figure, which of the following configuration of the VLAN on the Huawei switch is correct? (Multiple choice)

- A. Client1 belongs to VLAN 10, and the command for dividing VLAN on the switch is correct. (Right Answers)
- B. Client2 belongs to VLAN 20, and the command for dividing VLAN based on MAC address on the switch is correct. (Right Answers)
- C. Client3 belongs to VLAN 30, and the command for dividing VLAN on the switch is correct.
- D. Client4 belongs to VLAN 40, and the command for dividing VLAN on the switch is correct.
- E. Client4 does not belong to VLAN 40, and the command for dividing VLAN on the switch is incorrect. (Right Answers)

Answer: ABE

543. In the link aggregation technology, which parameters can the Eth-Trunk use to implement load balancing? (Multiple choice)

- A. Same source IP address or destination IP address (Right Answers)
- B. Same source port number or destination port number
- C. Same source MAC address or destination MAC address (Right Answers)
- D. The same protocol type

Answer: AC

544. The Trunk port can allow multiple VLANs to pass, including VLAN4096.

- A. True
- B. False (Right Answers)

Answer: B

545 As shown in the figure, the administrator wants all hosts to access the Internet from 8:00 to 17:00 every day. In the interface configuration of G0/0/1, which AGL rule should be bound to traffic-filter outbound?

- A. time-range am9topm5 08:00 to 11:00 working-day # acl number 2003 rule 5 deny time-range am9topm5
- B. time-range am910pm5 08:00 to 17:00 daily # acl number 2002 rule 5 permit time-range am910pm5 #
- C. time-range am9topm5 08:00 to 17:00 daily # acl number 2001 rule 5 deny time-range am9topm5 # (Right Answers)
- D. time-range am9topm5 08:00 to 17:00 off-day # acl number 2004 rule 5 permit time-range am910pm5

Answer: C

546. The router output information is as follows. What is the IPv6 address obtained by this interface?

- A. 3000::3000/64
- B. 3000::1/64
- C. 3000::2/64 (Right Answers)
- D. 2000::1/64

Answer: C

547 Which of the following features is no longer supported by OSPFv3 on an IPv6 network?

- A. Router-ID
- B. Multi-regional division
- C. Authentication function (Right Answers)
- D. Send protocol packets in multicast mode

Answer: C

548. Which packet is sent by the DHCPv6 client in response to the Advertise packet sent by the DHCPv6 server?

- A. Offer
- B. Request **(Right Answers)**
- C. Reply
- D. Advertise

Answer: B

549. The configuration information of a router's DHCP address pool is as follows. If the host adopts DHCP autoconfiguration, which IP addresses can the host obtain? (Multiple choice)

```
dhcpserver pod test
address prefix 3000:164
excluded-address 3000:1
dns-server 2000:1
dns-domain-name huawei dns-domain-name huawercom
```

- A. 3000:2/64 **(Right Answers)**
- B. 13-30900/64
- C. 3000:3000/64 **(Right Answers)**
- D. 0:2000-1/64

Answer: AC

550. Segment Routing (SR) is a protocol for extending the existing IGP protocol, based on the MPLS protocol, using source routing technology to forward data packets on the network.

- A. True **(Right Answers)**
- B. False

Answer: A

551. If the router's Ethernet interface needs to forward a 1600B packet, which of the following statements is correct? (Multiple choice)

- A. The value of the Flags field of the first packet is 1 **(Right Answers)**
- B. The first message contains the payload 1480B **(Right Answers)**
- C. The slice offset field value of the second fragmented packet is 1480 **(Right Answers)**
- D. The value of the Flags field of the second packet is a

Answer: ABC

552. There is a TTL field in the header of the IP packet. Which of the following statements about this field is correct?

- A. This field is used to indicate the priority of the packet.
- B. The length of this field is 7 digits.
- C. This field is used for packet anti-loop. **(Right Answers)**
- D. This field is used for packet fragmentation.

Answer: C

553. After the network administrator uses the Traceroute function on the router device, what is the value of the Protocol field of the IPv4 header in the data packet sent by the router?

- A. 6
- B. 1 **(Right Answers)**
- C. 17
- D. 2

Answer:

554 As shown in the following figure, host C is only required to communicate with one of host A or host B. Then, which of the following can be configured to implement the requirement under the G0/0/13 port of SWB?

- A mtu 2000
- B port link-type trunk
- C speed 100
- D mac-limit maximum 1 (Right Answers)

Answer: D

555 As shown in the following figure, the MAC address table of the SWA is as follows. The switch can never learn the MAC address of the HOST A. Which of the following reasons is not possible?

- A HOST A did not send any data frames
- B The G0/0/1 port of the switch is set to ACCESS mode (Right Answers)
- C The MAC address learning function is disabled on G0/0/1 of the switch.
- D Turn off the MAC address learning function of the LAN to which HOST A belongs.

Answer: B

556 The network administrator finds that a port on the switch has learned the MAC address, but cannot forward the data frame. Which of the following working states is the port in?

- A Disabled
- B Blocking
- C Listening
- D Learning (Right Answers)

Answer: D

557 As shown in the following figure, host A does not have a gateway configured. Host B has a gateway ARP cache. In host A, the command ping 110.12.1 is used. Which of the following statements is correct?

- A The destination MAC address of the data frame sent by Host A is MAC-B.
- B The destination MAC address of the data frame sent by Host A is MAC-A.
- C The destination IP address of the packet sent by host A is 110.12.1.
- D No packets will be sent from host A (Right Answers)

Answer: D

558. In Huawei AR routers, what is the default OSPF priority value?

- A. 20
- B. 10 (Right Answers)
- C. 30
- D. 0

Answer: B

559. When configuring a static route on a broadcast interface, you must specify the next hop address.

- A. True (Right Answers)
- B. False

Answer: A

560. In the OSPF broadcast network, which routers do the DR other routers exchange link state information with? (Multiple choice)

- A. DR (Right Answers)
- B. BDR (Right Answers)
- C. All OSPF neighbors
- D. DR Other

Answer, AB

561. What is the value of the direct routing protocol priority?

- A. 0 (Right Answers)
- B. 30
- C. 10
- D. 20

Answer: A

562. The configuration information of the G0/0/1 port of the switch is as follows. Which VLAN data frame does the switch forward not carry the VLAN TAG?

```
interface GigabitEthernet0/0/1
port link-type trunk
port trunk pvid vlan 10
port trunk allow-pass vlan 10 20 30 40
```

- A. 10 (Right Answers)
- B. 30
- C. 40
- D. 20

Answer: A

563. Referring to the following topology and configuration, routers R1 and R2 are connected through a Serial low-speed cable, and the data link layer encapsulation uses PPP. When the Holdtimes of R1 and R2 are inconsistent, PPP negotiation fails and communication cannot be performed.

- C A True
- C B False (Right Answers)

Answer: B

564. PPP is more secure and reliable than HDLC because PPP supports (). (Multiple choice)

- A. SSH
- B. PAP
- C. MD5
- D. CHAP

Answer: BD

565. The configuration information of G0/0/1 interface of Router A is as follows. Which of the following statements are correct? (Multiple Choice)

```
acl number 3000
rule 5 deny 17
rule 10 deny 89
rule 15 deny 6
```

```
interface GigabitEthernet0/0/1
traffic-filter inbound acl 3000
```

- A. This interface does not forward ICMP packets.
- B. This interface does not forward received SNMP packets. (Right Answers)
- C. This interface does not forward received FTP packets. (Right Answers)
- D. This interface can establish OSPF neighbor relationships with other routers.

Answer: BC

566. Layer 2 ACL can match source MAC, destination MAC, source IP, and destination IP, etc. information.

- A. True
- B. False (Right Answers)

Answer: B

567. What is the value of the protocol type field in the FP packet, indicating that the protocol is GRE?

- A. 47 (Right Answers)
- B. 48
- C. 2
- D. 1

Answer: A

568. OSPFv2 supports IPv6 by adding new types of LSAs.

- A. True
- B. False (Right Answers)

Answer: B

569. Which of the following parts does the global unicast address consist of? (Multiple Choice)

A. Protocol ID

B. Interface ID (Right Answers)

C. Subnet ID (Right Answers)

D. Global Routing Prefix (Right **Answers**)

Answer: BCD

570. The output information of Router C is as follows. How many global unicast address prefixes does Router C advertise?

A. 1

B. 2

C. 3 (Right Answers)

D. 4

Answer: C

571. What are the values of the currently used IPv6 multicast address flag field (Flag)? (Multiple Choice)

A. 0 (Right Answers)

B. 1 (Right Answers)

C. 2

D. 3

Answer: AB

572. Which of the following statements about the TTL field in the IP packet header is correct?

A. Whenever a IP packet passes through a router, its TTL value is decremented by 1. (Right Answers)

B. Whenever a IP packet passes through a router, its TTL value will be increased by 1.

C. TTL defines the time interval at which the source host can send packets.

D. TTL defines the number of packets that the source host can send.

Answer: A

573. Which of the following is not included in the VRP system login method?

- A. Telnet
- B. SSH
- C. Netstream **(Right Answers)**
- D. Web

Answer: C

574. Which of the following information is used to prompt by the VRP operating platform for incomplete input commands?

- A. Error: Wrong parameter found at w position
- B. Error: Incomplete command found at w position **(Right Answers)**
- G. Error. Too many parameters found at w position
- D. Error Ambiguous command found at "position

Answer: B

575. Which of the following descriptions about the specified port of the spanning tree is correct?

- A. The port on the root switch must not be the designated port.
- B. The designated port can forward configuration BPDUs to the network segment connected to it. **(Right Answers)**
- G. Each switch has only one designated port
- D. Specify the port to forward configuration BPDUs from this switch to the root switch.

Answer: B

576 Which of the following statements about the handling of RSTP configuration BPDU are correct? (Multiple Choice)

- A After the topology is stable, the non-root bridge device sends configuration BPDUs at the interval specified by the Hello timer, regardless of whether the configuration BPDUs are received from the root bridge. **(Right Answers)**
- B After the topology is stable, the non-root bridge device sends the configuration BPDU after receiving the configuration BPDU sent by the upstream device.
- C The root port must wait for the BPDU Max Age timeout to re-top the topology calculation.
- D When a port receives a sub-optimal RST BPDU from the upstream designated bridge, the port immediately responds to its stored RST BPDU. **(Right Answers)**

Answer: AD

577. Which of the following statements are incorrect? (Multiple Choice)

- A. By default, the order of route priorities is that direct routes are higher than OSPF.
- B. In VRP, the greater the priority value of the routing protocol, the higher the priority of the route. **(Right Answers)**
- C. The priority of each static route can be different
- D. If the cost of the route is larger, the higher the priority of the route. **(Right Answers)**

Answer: BD

578 Which of the following descriptions are incorrect about the OSPF Router ID? (Multiple Choice)

- A. The prerequisite for the normal operation of OSPF protocol is that the router has a router ID.
- B. The router ID must be the IP address of an interface of the router. **(Right Answers)**
- G. The router ID must be specified by manual configuration. **(Right Answers)**
- D. The router IDs must be the same in the same area. The router IDs in different areas can be different. **(Right Answers)**

Answer: BCD

579 When a router forwards a packet, if it does not match the corresponding detail route and there is no default route, the router will discard the packet directly.

- A. True **(Right Answers)**
- B. False

Answer: A

580 After the administrator successfully logs in to the router through Telnet, it is found that the IP address of the interface can not be configured on the muter. So what is the possible reason?

- A SNMP parameter configuration error
- B The Telnet terminal software used by the administrator prohibits the corresponding operation.
- C The Telnet user level is incorrectly configured (Right Answers)
- D The authentication mode of the Telnet user is incorrectly configured.

Answer: C

581 In the network shown in the following figure, the switch uses the VLANIF interface to connect to the sub-interface of the muter. Which of the following configurations can fulfill this requirement?

!!!

- A interface Mandl ip address 100.12.1.255/255.255.0 # interface GigabitEthernet0/0/2 pod link-type hybrid pod hybrid untag Nan 10 #
- B interface Vbnif10 ip address 100.121.255.255/255.0 # interface GigabitEthernet0/0/2 pod link-type access pod default Nan 10 #
- C interface Vlanif10 ip address 100.12.1.255/255.255.0 # interface GigabitEthernet0/0/2 pod link-type trunk pod trunk allow-pass Nan 10 # (Right Answers)
- D interface Vbnif10 ip address 10.12.1.255/255.255.0 # interface GigabitEthernet0/0/2 pod link-type trunk pod trunk pvid 10 pod trunk allow-pass Nan 10 #

Answer: C

582. If an Ethernet data frame Lengthtype=0(8100, which of the following ports might this data frame be sent from? (Multiple Choice)

- A. Switch Hybrid type port (Right Answers)
- B. Switch Access type port
- C. Serial interface of the router
- D. Switch Trunk type port (Right Answers)

Answer: AD

583 As shown in the figure, the two ports of switch GE0/0/1 and GE0/0/2 perform different Hybrid configurations. Which of the following statements are correct? (Multiple Choice)

- A. The data frame sent by the finance department carries the tag in the switch as VLAN20. (Right Answers)
- B. The administrative department and the finance department cannot visit each other because the VLANs belonging to the two departments are different.
- C. If both ports GE0/0/1 and GE0/0/2 of the switch are modified to be trunk pods, the two departments can communicate normally.
- D The data frame sent by the administrative department carries the tag in the switch as VLAN20
- E The switch here can be a Layer 2 switch or a Layer 3 switch because communication does not need to go through a Layer 3 gateway (Right Answers)

Answer: AE

584 In the LPP negotiation phase of the PPP protocol, if the parameters sent by the other party are completely accepted, which of the following packet will be sent?

- A Configure-Reject
- B. Configure-Ack (Right Answers)
- C. Configure-Request
- D Configure-Nak

Answer: B

585 As shown in the following figure, which of the following configurations can be used to make Host A and Host B unable to communicate with each other? (Multiple Choice)

- A. `acl number 2000 rule 5 deny source 100 0 12_0 0 0 0255 # interface GmabitEthernet0.10/3 traffic-filter inbound eel 2000 #`
- B. `acl number 2000 rule 5 deny source 100.0.120 0.0 0255 # interface GigabitEthernet0/0/1 traffic-filter outbound net 2000 # (Right Answers)`
- C. `acl number 2000 rule 5 deny source 100 0.12 0 0.0.0255 # interface GigabitEthernet0/0/1 traffic-filter inbound eel 2000 #`
- D. `acl number 2000 rule 5 deny source 1000.120 0.0.0_255 # interface GigabitEthernet0/0/2 traffic-filter inbound eel 2000 # (Right Answers)`

Answer: BB

586. The output information of Router C is as follows: what is the source IPv6 address of Router C sending OSPFv3 LSU packets?

111

- A. 2603:1/64
- B. FE80::2E0:FGFEFE48:4EC8 (Right Answers)
- C. 2005: 1/64
- D. 2009-1/64

Answer: B

587. Which of the following message types is used for the RA message that is used for IPv6 stateless autoconfiguration?

- A. IGLv1Pv6
- B. IGLv1Pv5 (Right Answers)
- C. UPv5
- D. TCPv6

Answer: B

588 The FEC (Forwarding Equivalence Class) is a set of data streams with certain commonalities; the FEC can be divided according to the address but cannot be divided according to the service type, CoS, etc.

- A. True
- B. False (Right Answers)

Answer: B

589 Which statement is correct about the function of the network layer in the OSI reference model?

111 A. The closest layer to the user in the OSI reference model, providing network services for applications

B Transmit bitstreams between devices, specifying levels, speed, and cable pins

C. Provide connection-oriented or non-connection-oriented data transfer and error detection before retransmission

D Provide a logical address for the router to determine the path (Right Answers)

E. Combine the bits into bytes, combine the bytes into frames, use the link layer address (the Ethernet uses the MAC address) to access the medium, and perform error detection.

Answer: D

590 UDP does not guarantee the reliability of data transmission. It does not provide functions such as packet sorting and flow control. It is suitable for traffic with low transmission reliability requirements but high transmission speed and delay.

A True (Right Answers)

B False

Answer: A

591. If the application layer protocol is Millet, what is the value of the Protocol field in the IP header?

A. 17

B. 67

C. 53

D. 6 (Right Answers)

Answer: D

592. The MAC address table of the existing switch is as follows. The switch receives a data frame with a source MAC address of 5489-9811-0b49 and a destination MAC address of 5489-989d-1d30. Which of the following statements are correct? (Multiple Choice)

111

A. If this data frame is received from Eth0/0/1, the switch will discard this data frame (Right Answers)

B If the data frame is received from Eth0/0/1, the switch forwards the data frame from the Eth0/0/3 port.

C If the data frame is received from Eth0/0/1, the switch floods the data frame.

D If the data frame is received from the Eth0/0/3 port, the switch forwards the data frame from the Eth0/0/1 port (Right Answers)

Answer: AD

593. SWA and SWB run the RSTP protocol. Which of the following statements are correct? (Multiple Choice)

A. The G0/0/13 port of SWA is the designated port. (Right Answers)

B. The G0/0/3 port of SWB is the alternate port. (Right Answers)

C. The G0/0/3 port of SWB is the Backup port.

D. The G0/0/12 port of SWA is the designated port. (Right Answers)

Answer: ABD

594. On the VRP platform, what is the order of the default protocol priorities of direct route, static route, RIP, and OSPF from high to low?

- A. Direct route, OSPF, static route, RIP (Right Answers)
- B. Direct route, OSPF, RIP, static route
- C. Direct route, RIP, static route, OSPF
- D. Direct route, static route, RIP, OSPF

Answer: A

595. As shown in the following figure, assume that all routers run OSPF at the same time. Which router is the DR in this network?

- A. Router A
- B. Router B (Right Answers)
- C. Router C
- D. Router ID

Answer: B

596. The OSPF router ID must be the same as the IP address of an interface on the router.

- A. True
- B. False (Right Answers)

Answer: B

597. What are the functions of OSPF hello packets? (Multiple Choice)

- A. Publish parameter information such as Router ID and Router Priority. (Right Answers)
- B. Synchronous router LSDB
- C. Neighbor discovery (Right Answers)
- D. Maintaining neighbor relationships (Right Answers)

Answer: ACD

598. By default, what is the OSPF protocol Deadtime on the broadcast network?

- A. 20s
- B. 40s (**Right Answers**)
- C. 10s
- D. 30s

Answer: B

599. When two OSPF routers form a TWO-WAY neighbor relationship, the LSDB has completed synchronization, but the SPF algorithm has not been run.

- A. True
- B. False (Right Answers)

Answer: B

600. Which of the following protocol does not belong to the File Transfer protocol?

- A. TFTP
- B. HTTP (**Right Answers**)
- C. FTP
- D. SFTP

Answer: B

601. Which of the following is correct about the VLANIF interface?

- A. The VLANIF interface does not need to learn the MAC address.
- B. Different VLANIF interfaces can use the same IP address.
- C. The VLANIF interface does not have a MAC address.
- D. The VLANIF interface is a Layer 3 interface. (**Right Answers**)

Answer: D

602. The rule for creating a VLAN on a Huawei switch is that VLAN4095 cannot be created and VLAN 1 cannot be deleted.

- A. True (Right Answers)
- B. False

Answer: A

603. As shown in the following figure, the switch configuration information is as follows. Which of the following statements are correct? (Multiple Choice)

```
interface GigabitEthernet0/0/1
port hybrid pvid vlan 20
port hybrid untagged vlan 10 20
```

```
interface GigabitEthernet0/0/2
port hybrid pvid vlan 10
port hybrid untagged vlan 10 20
```

- A. Host A and Host B can ping each other. **(Right Answers)**
- B. Data frames on both links do not contain VLAN TAG **(Right Answers)**
- C. Host A and Host B cannot ping
- D. The PVID of the port GigabitEthernet 0/0/1 is 20 **(Right Answers)**

Answer: ABD

604. Which of the following protocol does the PPP protocol consist of? (Multiple Choice)

- A. Certification Agreement **(Right Answers)**
- B. NCP **(Right Answers)**
- C. LCP **(Right Answers)**
- D. PPPOE

Answer: ABC

605. Which of the following value is used in the Protocol field in the PPP frame to indicate that the core is an IP packet?

- A. 0x8821
- B. 0x0021 **(Right Answers)**
- C. 0x8021
- D. 0x8863

Answer: B

606 As shown in the following figure, all the hosts can communicate with host C through which of the following configuration?
But host A and host B cannot communicate.

- A. `acl number 4000 rule 5 deny destination-mac 5489-98ea-4c7c source-mac 5489-98d3-104d # interface GigabitEthernet0/0/1 traffic-filter inbound eel 4000`
- B. `eel number 4000 rule 5 deny destination-mac 5489-93ea-4c7c source-mac 5489-98c0-550e # interface GigabitEthernet0/0/1 traffic-filter inbound eel 4000 4 (Right Answers)`
- C. `act number 4000 rule 5 deny destination-mac 5489-98ea-4c7c source-mac 5489-98c0-550e # interface GigabitEthernet0/0/1 traffic-filter outbound eel 4000`
- D. `act number 4000 rule 5 deny destination-mac 5489-98ea-4c7c source-mac 5489-98d3-104d # interface GigabitEthernet0/0/1 traffic-filter outbound act 4000`

Answer: B

607. As shown in the following figure, which of the following configurations can be used to make Host A and Host B unable to communicate with each other? (Multiple Choice)

- A. `act number 2000 rule 5 deny source 1000_12 0 0 0 255 # interface GigabitEthernet0/0/1 traffic-filter inbound ad 2000 lt`
- B. `lad number 2000 rub 5 deny source 100 0.12 0 0 0 255 # interface GigabitEthernet0/0/3 traffic-filter inbound eel 2000 4`
- C. `act number 2000 rule 5 deny source 1000.12 0 0.0.0.255 # interface GigabitEthernet0/0/1 traffic-filter outbound eel 2000 4 (Right Answers)`
- D. `act number 2000 rule 5 deny source 100.0.12.0 0.0.0.255 # interface GigabitEthernet 0/0/2 traffic-filter inbound eel 2000 # (Right Answers)`

Answer: CD

608. As shown in the following figure, the administrator wants that all the hosts cannot access the Web service (port number is 80) and other services are accessed normally, what ACL rule should be bound to traffic-filter outbound in the interface configuration of G0/0/1?

EI

- A. `act number 3001 rule 5 deny udp destination-port eq www rule 10 porn #`
- B. `act number 3003 rule 5 permit ip rule 10 deny udp destination-port eq www #`
- C. `act number 3000 rule 5 deny tcp destination-port eq www rule 10 permit ip # (Right Answers)`
- D. `act number 3002 rule 5 permit ip rule 10 deny tcp destination-port eq www #`

Answer: C

609. What is the decimal value of the OSPFv3 packet in the Protocol field in the IPv6 packet header?

- A. 69
- B. 89 (Right Answers)
- C. 92
- D. 59

Answer: B

610. Which of the following IPv6 address Solicited-node multicast addresses are F02:1:FFAB:FECA? (Multiple Choice)

- A. 2030::BBAB:FECA (Right Answers)
- B. 2020::EEAB:FECA (Right Answers)
- C. 2020::FFAB:FECA (Right Answers)
- D. 2020::FFBA:FECA

Answer: ABC

611. Which of the following IPv6 addresses are link-wide multicast addresses? (Multiple Choice)

- A. FF02::2 (Right Answers)
- B. FF02::1 (Right Answers)
- C. FF12::1 (Right Answers)
- D. FF12::2 (Right Answers)

Answer: ABCD

612. What is the total length of the interface identifier of the link-local unicast address?

- A. 48bit
- B. 32bit
- C. 64bit (Right Answers)
- D. 96bit

Answer: C

613. The LER in the MPLS domain is called the Label Egress Router.

- A. True
- B. False (Right Answers)

Answer: B

614. If the value of the Type/Length field of an Ethernet data frame is 0x0800, the header length of the upper packet carried by the data frame ranges from 20 to 60B.

- A. True (Right Answers)
- B. False

Answer: A

615. On the VRP platform, which of the following methods can you access the previous history command? (Multiple Choice)

- A. Left cursor
- B. Ctrl+U
- C. Ctrl+P (Right Answers)
- D. Upper cursor (Right Answers)

Answer: CD

616. What is the full name of VRP?

- A. Virtual Routing Platform
- B. Versatile Redundancy Platform
- C. Versatile Routing Protocol
- D. Versatile Routing Platform (Right Answers)

Answer: D

617 As shown, the figure, three Layer 2 switches are interconnected with one HUB, and the switch is enabled with SIP. For the bridge ID setting of the switch SIP, refer to the following Figure. Others are default configurations. Which of the following statements is wrong?

- A After the bridge ID comparison, LSW1 is the master bridge
- B 130/0/1 port of LSW3 is an FP port and is blocked
- C Both ports of LSW1 are designated ports and are in a forwarding state (Right Answer)
- D. port of LSW1 is blocked

Answer: C

618 As shown in the following figure, all switches run the STP protocol. After the topology is stable, modify the sending period of the configuration BPDU on which of the following switches can affect the sending period of the STP configuration BPDU?

- A SWD
- B SWG
- C SWB
- D SWA (Right Answers)

Answer:

619. As shown in the network below, the MAC address of the switch is marked. Enter the command stp root secondary on the SWD switch. Which of the following switches will be the root bridge of this network?

- A SWD (Right Answers)
- B SWB
- C SWC
- D SWA

Answer: A

620. The company has users who report that when using the company network to transfer files, the speed is very slow. The administrator uses Wireshark software to capture packets in the network and finds some Oupscale frames. Which of the following descriptions is correct about the reason or solution?

- A The switching equipment of the company network must be upgraded
- B. The network has a loop on the second floor (Right Answers)
- C No VLAN is configured in the network
- D. When the switch finds the destination MAC address of the data frame in the MAC address table, the switch will flood the data frame.

Answer: C

621. Dynamic routing protocols can automatically adapt to changes in network topology.

- A. True **(Right Answers)**
- B. False

Answer: A

622. The output information of the router R1 routing table is as follows. Which of the following statements are correct? (Multiple Choice)

- A. The packet with the destination address of 10.0.2.2 is forwarded through Ethernet0/0/1. **(Right Answers)**
- B. The packet with the destination address of 10.0.1.1 is forwarded through the Ethernet0/0/0 interface. **(Right Answers)**
- C. The packet with the destination address of 10.1.1.1 is forwarded through the GigabitEthernet0/0/0 interface.
- D. The packet with the destination address of 10.0.2.1 is forwarded through the Ethernet0/0/2 interface. **(Right Answers)**

Answer: ABD

623. All interfaces of the router belong to the same broadcast domain.

- A. True
- B. False **(Right Answers)**

Answer: B

624. Which of the following is correct about the command configured for the default route?

- A. [Huawei] ip route-static 0.0.0.0 0.0.0.0 192.168.11 **(Right Answers)**
- B. [Huawei-Serial0] ip route-static 0.0.0.0 0.0.0.0 0.0.0.0
- C. [Huawei] ip route-static 0.0.0.0 255.255.255.255 192.168.1.1
- D. [Huawei] ip route-static 0.0.0.0 0.0.0.0 0.0.0.0

Answer: A

625. What are the advantages of using DHCP to allocate IP addresses using Dynamic Host Configuration Protocol? (Multiple Choice)

- A. Can achieve IP address reuse **(Right Answers)**
- B. Avoid IP address conflicts **(Right Answers)**
- C. Heavy workload and poor management
- D. The configuration information changes (such as DNS), only the administrator needs to modify it on the DHCP server to facilitate unified management. **(Right Answers)**

Answer: ABD

626. As shown in the following figure, Router A has passed the IP address 10.0.122.1 to Telnet Router B in the current interface, which of the following operations will cause the Telnet session of the router to be interrupted with router? (Multiple Choice)

- A. Close G0/0/1 interface (Right Answers)
- B. Modify the IP address of G0/0/1 interface (Right Answers)
- C. Enable OSPF protocol on G0/0/1 interface
- D. Configure static router

Answer: AB

627. When a port of a switch receives a non-carried VLAN TAG data frame, it must add a PVID.

- A. True (Right Answers)
- B. False

Answer: A

628. Which of the following parameter cannot be used for advanced access control lists?

- A. Physical interface (Right Answers)
- B. Time range
- C. Destination port number
- D. Agreement number

Answer: A

629. The ACL does not filter the traffic that the device itself generates to access other devices. Only the forwarded traffic is filtered. The forwarded traffic includes traffic that other devices access the device.

- A. True (Right Answers)
- B. False

Answer: A

630. An ACL rule is as follows: Which of the following IP addresses can be matched by the permit rule? (Multiple Choice)

Rule 5 permit ip source 10.9.1.0 255.0.254.255

- A. 7.1.2.1
- B. 6.1.3.1 (Right Answers)
- C. 8.2.2.1
- D. 9.9.1.1 (Right Answers)

Answer: BD

631. The router output information is as follows. Which IPv6 address is obtained by this interface?

- A. 2000::1/64
- B. 3000::2/64 (Right Answers)
- C. 3000::3000164
- D. 3000::1/64

Answer: B

632. The router's Router ID neighbor relationship is as follows. Which of the following statements are correct? (Multiple Choice)

- A. The router and the router with Router-ID 10.5.3.3 cannot exchange the link status information. (Right Answers)
- B. This router is a DR Other router (Right Answers)
- C. The router-ID of the DR router is 10.0.1.1. (Right Answers)
- D. The router-ID of the DR router is 10.0.0.2. (Right Answers)

Answer: ABCD

633. Which area number does OSPFv3 use to identify the backbone area?

- A. 0 (Right Answers)
- B. 3
- C. 1
- D. 2

Answer: A

634. A router OSPFv3 adjacency relationship is as follows. The router is an ABR.

- A. True (Right Answers)
- B. False

Answer: A

635. Which of the following type of addresses are not included in the IPv6 address?

- A. Anycast address
- B. Broadcast address (Right Answers)
- C. Multicast address
- D. Unicast address

Answer: B

636. If the network address of a network is 10.1.1.0/30, what is its broadcast address?

- A. 10.1.1.4
- B. 10.1.1.2
- C. 10. 1. 1.3 (Right Answers)
- D. 10.1.1.1

Answer: C

637. If the network address of a network is 192.168.1.0, then its broadcast address must be 192.168.1.255.

- A. True
- B. False (Right Answers)

Answer: B

638. Which of the following are correct about the analysis of ICMP packets? (Multiple Choice)

- A. ICMP packets are encapsulated in IP packets and are not encapsulated in the transport layer. (Right Answers)
- B. ICMP packets cannot be used to detect MTUs in a path.
- C. ICMP messages can record time, including original time, receiving time, and sending time. (Right Answers)
- D. ICMP protocol does not support redirection function
- E. ICMP packets contain ICMP error packets, control packets, request/response packets, and refresh packets.

Answer: AC

639. When the router is powered on, the configuration file is read from the default storage path for initialization of the router. If there is no configuration file in the default storage path, what does the router use for initialization?

- A. Current configuration
- B. New configuration
- C. Default parameters (Right Answers)
- D. Initial configuration

Answer: C

640. In the STP protocol, which of the following factors will affect the election of the root switch? (Multiple Choice)

- A. Switch interface ID
- B. Switch interface bandwidth
- C. IP address of the switch
- D. The current MAC address of the switch (Right Answers)
- E. Switch priority (Right Answers)

Answer: DE

641. As shown in the following figure, all switches run STP, when the topology is stable. The SWA device is powered off. Which of the following statements are correct? (Multiple Choice)

CI

- A. SWB still periodically sends configuration BPDUs from port GO/0/1.
- B. The SWC sends configuration BPDUs from port GO/0/1 after the current Max Age time.
- C. SWC immediately sends TC-BPDUs from port GO/0/1 (Right Answers)
- D. SWC and SWB immediately re-elected the root bridge (Right Answers)

Answer: CD

642. As shown in the figure, all four switches run STP, and each parameter adopts the default value. When a port on the root switch is blocked and cannot be sent through the port, how long will the port in the network enter the forwarding state?

- A. About 15 seconds
- B. About 50 seconds (Right Answers)
- C. About 30 seconds
- D. About 3 seconds

Answer: B

643. Which of the following port states does the RSTP protocol include? (Multiple Choice)

- A. Forwarding (Right Answers)
- B. Discarding (Right Answers)
- C. Listening
- D. Learning (Right Answers)

Answer: ABD

644. As shown in the figure below, all hosts can communicate normally. Which of the following statements are correct? (Multiple Choice)

- A. SWB's 301013 learned 2 MAC addresses (Right Answers)
- B. SWA's G01013 learned 3 MAC addresses
- C. SWA's G010/3 learned 1 IPv4 address (Right Answers)
- D. SWA's G0/0/3 learns 2 MAC addresses

Answer; AC

645 The Layer 2 switch belongs to the data link layer device and can identify the MAC address information in the data frame, forward the data according to the MAC address, and record the MAC address and the corresponding port information in its own internal MAC address table.

- A. True (Right Answers)
- B. False

Answer, A

646. Which of the following description is wrong about the Layer 2 Ethernet switch?

- A. Layer 2 Ethernet switch works at the data link layer
- B. Ability to learn MAC address
- C. Forward according to the Layer 2 header information of the Ethernet frame
- D. If it is necessary to make certain modifications to the three-layer header of the forwarded message, and then forward it. (Right Answers)

Answer: D

647. If the network shown in the following figure is used to enable loopback 0 communication between Router A and Router B through static routes, which of the following command should be entered in Router A?

- A. ip route-static 10.0.22.32 GigabitEthernet 0/0/0
- B. ip route-static 10.0.22.0 GigabitEthernet 0/0/0
- C. ip route-static 10.0.2.2 255.255.255.255 100 12 2 (Right Answers)
- D. ip route-static 10.0.2.2 255.255.255.255 100 12 1

Answer: C

648. As shown in the figure, regarding OSPF topology and configuration, which of the following statements is correct?

- A. Compared with R2, R1 has a better chance of becoming an OR because its interface OR priority value is smaller
- B. R1 and R2 can establish stable neighbor relationships as long as the interface network type of R1 is restored to the default broadcast type.
- C. As long as the interface network type of R1 is restored to the default broadcast type, and the hello time is adjusted to 10s, R1 and R2 can establish a stable neighbor relationship. (Right Answers)
- D. R1 and R2 can establish stable OSPF neighbor relationships

Answer: C

E49. As shown in the following figure, the following configurations exist on Router A. Which of the following statements are correct? (Multiple Choice)

```
ip route-static 10.0.2.2 255.255.255.100 0.12.2
ip route-static 10.0.22.255 255.255.10.0 21 2 preference 40
```

A

- A. If the port GO/0/1 is Down, the interface that reaches 10.0.2.2 in the routing table of Router A is changed to GO/0/2.
- B. If the GO/0/2 port is Down, the interface that reaches 100.22 in the routing table of Router A is changed to GO/0/1. (Right Answers)
- C. The interface that reaches 10.0.2.2 in the routing table of Router A is GO/0/1
- D. The interface that reaches 10.0.2.2 in the routing table of Router A is GO/0/12. (Right Answers)

Answer: BD

650. As shown in the broadcast network, OSPF runs on four routers and in the same area and on the same network segment. OSPF automatically elects an OR. Multiple BDRs to achieve better backup results.

- A. True
- B. False (Right Answers)

Answer: B

651. When logging in to the router through Telnet, which authentication methods can choose? (Multiple Choice)

- A. AAA local authentication (Right Answers)
- B. Not certified
- C. password authentication (Right Answers)
- D. MD5 ciphertext authentication

Answer: AC

652. The packet that the DHCP server responds to the client must be a unicast packet.

- A. True
- B. False (Right Answers)

Answer: B

653. Link aggregation is a common technique in enterprise networks. Which of the following descriptions are the advantages of link aggregation technology? (Multiple Choice)

- A. Improve reliability (Right Answers)
- B. Improve safety
- C. Increase bandwidth (Right Answers)
- D. Implement load sharing (Right Answers)

Answer: ACD

654. A switch receives a data frame with a VLAN tag, but finds that the destination MAC address of the data frame is not queried in its MAC address table which is the processing behavior of the switch for the data frame?

- A. The switch will drop this data frame
- B. The switch broadcasts this data frame to all Access ports.
- C. The switch broadcasts this data frame to all ports (except the receiving part) in the VLAN that belongs to the data frame (Right Answers)
- D. The switch broadcasts the data frame to all ports

Answer: C

655. In order to check whether the serial port SO/D/1 on the router is a DTE interface or a BCE interface, which of the following commands should he used?

- A. display interface 80/0/1 (Right Answers)
- B. display current-config
- C. display saved-config
- D. display controller serial

Answer: A

656. Which of the following types of ACLs can match the transport layer port number?

- A. Intermediate ACL
- B. Advanced ACL (Right Answers)
- C. Layer 2 ACL
- D. Basic ACL

Answer: B

657. What is the total length of an IPv6 address?

- A. 32
- B. 64
- C. 128 (Right Answers)
- D. 96

Answer: C

658. Which protocol packet is required to bear for DHCPv6 packets?

- A. FTP
- B. TCP
- C. UDP (Right Answers)
- D. HTTP

Answer: C

659. Which statements are correct about IPv6 address configuration? (Multiple Choice)

- A. FRC addresses can only be manually configured.
- B. IPv6 supports DHCPv6 format for address configuration (Right Answers)
- C. IPv6 supports stateless autoconfiguration (Right Answers)
- D. IPv6 address supports multiple ways of automatic configuration (Right Answers)

Answer: BCD

660. The multicast address of the requested node corresponding to 2001::12:1 is FF02::1:FF12:1.

- A. True (Right Answers)
- B. False

Answer: A

661. The client has an error accessing the FTP server. Checking that there is no problem with the connectivity between the server and the client is it possibly caused by which of the following server ports are blocked? (Multiple Choice)

- A. 21 (Right Answers)
- B. 20 (Right Answers)
- C. 50049
- D. 80

Answer: AB

662. Which fields are not included in the network layer header format?

- A. TTL
- B. Source IPv4 Address
- C. Sequence Number (Right Answers)
- D. Destination IPv4 Address

Answer: C

663. Which of the following descriptions are correct if an AR2200 router needs to be restored to its initial configuration? (Multiple Choice)

- A. Re-specify the configuration file to be loaded next time
- B. Reset the saved configuration (Right Answers)
- C. Clear current configuration
- D. Restart the AR2200 router (Right Answers)

Answer: BD

664. The administrator wants to completely delete the old device configuration file config.zip, then which of the following command is correct?

- A. delete /unreserved config.zip (Right Answers)
- B. delete /force config.zip
- C. clear config.zip
- D. reset config.zip

Answer: A

665. In which of the following cases does the switch generate configuration BPDUs? (Multiple Choice) A. During the initialization process, as long as the port is enabled with STP, the configuration BPDU will be sent from the designated port according to the interval specified by the Hello Time timer B. When the root port receives the configuration BPDU, the device where the root port resides sends configuration BPDUs from each of its designated ports. C. When a non-designated port receives a configuration BPDU that is worse than itself, it immediately sends its own BPDU to the downstream device. Answer ABD
 A.select this to commit (Right Answers)

Answer: A

666. The port cost calculated by STP has a certain relationship with the port bandwidth, that is, the larger the bandwidth, the () the overhead.

- A. Consistent
- B. Not necessarily
- C. bigger
- D. smaller (Right Answers)

Answer: D

667. In the RSTP protocol, the PIA mechanism requires that the link between two switching devices be in point-to-point full-duplex mode.

- A. True (Right Answers)
- B. False

Answer: A

668. The output information of a router is as follows. Which of the following statements are correct? (Multiple Choice)

- A. This router is DR (Right Answers)
- B. Router ID is 10.0.1.1
- C. Router ID is 10.0.2.2 (Right Answers)
- D. The interface address of this router is 10.0.12.2 (Right Answers)

Answer: ACID

669. Which of the following commands can enable the DHCP relay function of the router interface?

- A. dhcp select server
- B. dhcp select global
- C. dhcp select interface
- D. dhcp select relay (Right Answers)

Answer: D

670 As shown in the following figure, Switch A and Router A are connected through two links. The two links are in the manual load balancing mode. The aggregation port number is 1, and the aggregation link needs to forward data. Carrying VLAN TAG 100, which configuration does Router A need to use? (Multiple Choice)

- A. interface Eth-Trunk1 port link-type trunk port trunk allow-pass Nan 100 # interface GmabilEthernet0/0/1 eth-trunk 1 #
- E. interface GmabilEthemet0/1 eth-trunk 1 4 interface GmabilEthernet0/0/2 eth-trunk 1 (Right Answers)
- C. interface Eth-Trunk1 mode lacp-static port link-type trunk port trunk allow-pass Nan 100 4 interface GmabilEthernet0/0/1 eth-trunk 1 # interface GmabilEthernet0/0/2 eth-trunk 1 4
- B. interface Eth-Trunk1 undo portswitch # interface Eth-Trunk1_100 doll q termination vrd 100 ip address 10 0 122 255 255 2550 arp broadcast enable # (Right Answers)

Answer: B0

671 As shown in the figure, the network administrator creates VLAN 2 on the SWA and SWB, and configures the pods connected to the hosts on the two switches as access ports and assigns them to VLAN 2. Configure 60/0/1 of SWA and 61:11012 of SWB as trunk ports to allow all VLANs to pass. To achieve normal communication between the two hosts, what do you need to do?

- A. Configure G0011 on the SWC as the trunk port and G0012 as the access port.
- B. Create VLAN 2 on the SWC, configure G0/10/1 and G0/0/12 as trunk ports, and allow VLAN 210 pass. (Right Answers)
- C. Create VLAN 2 on the SWC.
- D. Configure G0/31/1 on the SWC as the trunk port and allow VLAN 2 to pass.

Answer: B

672 If the Authenticator sends the wrong username and password to the Authenticator during the PPP authentication process, what type of message will the Authenticator send to the Authenticator?

- A. Authenticate-Reject
- B. Authenticate-Ack
- C. Authenticate-Nak
- D. Authenticate-Reply

673. An ACL is a packet filter. The ACL is applied to the service module. The ACL takes effect.

A. True (Right Answers)

B. False

Answer: A

674. An ACL rule is as follows: Which of the following IP addresses can be matched by the permit rule? (Multiple Choice)

rule 5 permit ip source 10.0.1.0 0.0.254.255

- A. 10.0.4.5
- B. 10.0.3.4 (Right Answers)
- C. 10.0.1.2 (Right Answers)
- D. 10.0.2.3

Answer: BC

675. When an IPv6 interface receives a packet whose Hop Limit field has a value of 1, the packet is not forwarded.

A. True (Right Answers)

B. False

Answer: A

676_ By default, how many seconds is the OSPFv3 adjacency Deadtime on a P2P link?

- A. 40 (Right Answers)
- B. 10
- C. 20
- D. 30

Answer: A

677 An explicit path can be easily defined by SR (Segment Routing), and nodes in the network only need to maintain Segment Routing information. It can respond to the real-time rapid development of business.

What are the following characteristics of Segment Routing? (Multiple Choice)

- A Support both the centralized control mode of the controller and the distributed control mode of the repeater. Provides a balance between centralized control and distributed control (Right Answers)
- B SR (Segment Routing) uses IP forwarding without additional maintenance of another label forwarding table.
- C A better smooth evolution of existing networks by extending existing protocols such as IGP (Right Answers)
- D Using source routing technology to provide rapid interaction between the network and upper-layer applications (Right Answers)

Answer: ACD

678. Which of the following statement about MPLS Label tags is wrong?

- A. The tag is encapsulated between the network layer and the data link layer (Right Answers)
- B. The label is used to uniquely identify the forwarding equivalence class FEC burned by a packet.
- C. The label is carried by the header of the packet and does not contain topology information.
- D_ The tag is a short identifier with a fixed length and only local significance.

Answer: A

679. Which statement is correct about the VRP operating platform shortcuts? (Multiple Choice)

- A. CTRL+Z returns to the user view (Right Answers)
- B. CTRL+C stops the running of the current command (Right Answers)
- C. Move the left cursor key (<-->) to the left by one. (Right Answers)
- D. TAB prompts for the most recently entered command

Answer: ABC

680.<Huawei>system-view

[Huawei]user-interface console 0

[Huawei-ui-console0] user privilege level 15

[Huawei-ui-console0] authentication-mode password

[huawei-ui-console0] set authentication password cipher huawei2012

[Huawei-ui-console0]quit

Which statement is wrong about the above configuration command?

- A. The user who logs in to the device through the console has the highest user privilege level.
- B. The administrator wants to log in and manage the device through the console port.
- C. After the configuration is completed, the administrator cannot implement device management through remote login.
- D The password of the user who logs in to the device through the console is cipher huawei2012 (Right Answers)

Answer:

681. In the switch, which of the following is the technology of port and MAC binding?

- A. SEP
- B. NAT
- C. ACL
- D. Port Security **(Right Answers)**

Answer: D

682. Which of the following information does the switch MAC address table not include?

- A. MAC address
- B. Port number
- C. IP address **(Right Answers)**
- D. VLAN

Answer: C

683. What port states might exist on a switch with standard STP protocol enabled? (Multiple Choice)

- A. Discarding
- B. Listening **(Right Answers)**
- C. Disabled **(Right Answers)**
- D. Forwarding **(Right Answers)**

Answer: BCD

684. Which of the following routing protocols has the highest priority?

- A. Direct **(Right Answers)**
- B. RIP
- C. OSPF
- D. Static

Answer: A

685. Referring to the output result shown in the figure, it can be judged that the routing table of the router is composed of a direct route and a static route.

- A. True (Right Answers)
- B. False

Answer: A

686. Which of the following description is correct about the display information?

- A. GigabitEthernet 0/0/10 interface was manually closed by the administrator. **(Right Answers)**
- B. GigabitEthernet 0/0/0 interface is not configured with an IP address.
- C. GigabitEthernet 0/0/0 interface does not enable dynamic routing protocol
- D. GigabitEthernet 0/0/0 interface is connected with a wrong cable.

Answer: A

687. The output information of a link aggregation port of a switch is as follows. If you want to delete Eth-Trunk 1, which of the following command is correct?

- A. undo interface Eth-Trunk 1
- B. inte GigabitEthernet 0/0/1 undo eth-trunk quit undo interface Eth-Trunk 1 (Right Answers)
- C. inte GigabitEthernet 0/0/1 undo eth-trunk quit inte GigabitEthernet 0/0/2 undo eth-trunk quit undo interface Eth-Trunk!
- D. inte GigabitEthernet 0/0/2 undo eth-trunk quit undo interface Eth-Trunk 1

Answer: B

688. If an Ethernet data frame Length/Type=0x1234, which may be the payload of this data frame? (Multiple Choice)

- A. TCP data segment (Right Answers)
- B. UDP data (Right Answers)
- C. ICMP packet (Right Answers)
- D. ARP packet (Right Answers)

Answer: ABCD

689. As shown in the figure, a static NAT command is deployed on the router R1. When the PC accesses the Internet, the destination address in the packet will not change.

- A. True (Right Answers)
- B. False

Answer: A

690. What level of encapsulation format is defined by the PPP protocol in the OSI reference model?

- A. Network layer
- B. Data link layer (Right Answers)
- C. Presentation layer
- D. Application layer

Answer: B

691. Which of the following authentication methods does not require to input a username and password?

- A. authorization-mode hwtacacs
- B. authentication-mode local
- C. authentication-mode hwtacacs
- D. authentication-mode none (Right Answers)

Answer: D

692. When forwarding a IPv6 packet, the router needs to find the routing table based on the source IP address of the IPv6 packet.

- A. True
- B. False (Right Answers)

Answer: B

693. Which order is the OSI reference model from the upper layer to the lower layer?

- A. Application layer, session layer, presentation layer, transport layer, network layer, data link layer, physical layer
- B. Application layer, transport layer, network layer, data link layer, physical layer
- C. Application layer, presentation layer, session layer, transport layer, network layer, data link layer, physical layer (Right Answers)
- D. Application layer, presentation layer, session layer, network layer, transport layer, data link layer, physical layer

Answer: C

694. Network administrators use Ping to test network connectivity. Which of the following protocols might he used in the process? (Multiple Choice)

- A. ARP (Right Answers)
- B. TCP
- C. ICMP (Right Answers)
- D. UDP

Answer: AC

695. As shown in the figure, it can be judged that 00e0-fc99-999 is a specific host MAC address learned by the switch through ARP, and the host has changed the IP address three times.

- A. True
- B. False (Right Answers)

Answer: B

696.<Huawei>system-view [Huawei]command-privilege level 3 view user save

Which statement is correct about the above configuration command?

- A. Modify the `user` view command to a permission level of 3, and save the configuration.
- B. Modify the users permission level to 3, and save the configuration.
- C. Modify the permission level of the `save` command in the user view to 3. (Right Answers)
- D. Modify the permission level of the `save` command used by a user to 3

Answer: C

697. Which of the following OSPF protocol packets can ensure the reliability of the LSA update?

- A. [SACK (Right Answers)
- ID B. LSR
- C. DD
- D. LSU

Answer: A

698 Which of the following protocols does not belong to the file transfer protocol?

- A. SFTP
- B. TFTP
- C. FTP
- D. HTTP (Right Answers)

Answer: D

699. Apply the following ACL to Telnet:
Aci number 2000
Rule 5 permit source 172.16.105.20

Only devices with an IP address of 172.16.105.2 are allowed to log in remotely.

- A. True (Right Answers)
- B. False

Answer: A

700.[RTA] ac12002
[RTA-acl-basic-2002] rule deny source 172.16.1.1 0.0.0.0
[RTA-acl-basic-2002] rule deny source 172.16.0.0 0 255.0.0
Using the ACL matching rule entry shown above on the router RTA, which of the following entries will be matched? (Multiple Choice)

- A. 192.17.0.0/24
- B. 172.16.1.1/32 (Right Answers)
- C. 172.16.1.0/24
- D. 172.48.0.0/16 (Right Answers)

Answer: BD

701. Which type of ACL does the following command belong to?
rule permit 8021p 7

- A. Layer 2 ACL (Right Answers)
- B. Basic ACL
- C. Advanced ACL
- D. Intermediate ACL

Answer: A

702. How many bits does the total length of an IPv6 address increase over IPv4?

- A. 32
- B. 96 (Right Answers)
- C. 64
- D. 128

Answer: B

703. What kind of IPv6 address is FE80::2E0:FCFF:FE6F:4F36?

- A. Multicast address
- B. Anycast address
- C. Link-local address (Right Answers)
- D. Global unicast address

Answer: C

704. If the 11⁷¹v6 host wants to send packets up to 10 routers, which parameter should be modified in the Pve header?

- A. Next Header
- B. Version
- C. Hop Limit (Right Answers)
- D. Traffic Class

Answer: C

705. There are two routers RTA and RTB between the source device and the destination device. Use the Traced command to detect the path. When the first hop RTA is detected, the source device sends a UDP packet with a TTL of 1 to a larger port of the destination device. When the packet reaches the RTB, the TTL becomes 0, and the RTA responds to the source device. ICMP_____ message.

- A. Echo Request
- B. Port Unreachable
- C. Time Exceeded (Right Answers)
- D. Echo Reply

Answer: C

706. This is the three packets that the administrator has captured on the network. Which of the following statements is incorrect?

- A. These three packets represent the three-way handshake process of TCP.
- B. Application layer data is not included in all three packets
- C. The IP address of the Telnet server is 10.0.12.1; and the IP address of the Telnet client is 10.0.12.2. (Right Answers)
- D. The Telnet client uses the 50190 port to establish a connection with the server.

Answer: C

707. The administrator needs to configure the IP address on the G0f0/0 interface of the router. Which of the following address is correct to use?

- A. 145.4.2.55/26 (Right Answers)
- B. 237.6.1.2124
- C. 127.3.1.4128
- D. 192.168.10.112130

Answer: A

708. The subnet mask of a network segment 150.25.0.0 is 255.255.224.0, then which is the valid host address in the network segment? (Multiple Choice)

- A. 150.25.2.24 (Right Answers)
- B. 150.15.3.30
- C. 150.25.0.0
- D. 150.25.1.255 (Right Answers)

Answer: AD

709. How many port states does the RICMP protocol have?

- A. 2
- B. 4
- C. 3 (Right Answers)
- D. 1

Answer: C

710. A router running OSPF can reach the FULL state after completing the LSDB synchronization.

- A. True (Right Answers)
- B. False

Answer: A

711. Which of the following is not included in the routing table?

- A. MAC **(Right Answers)**
- B. Destination/Mask
- C. Cost
- D. NextHop

Answer: A

712. Which descriptions are correct about DD packets and LSA in OSPF? (Multiple Choice)

- A. The head of the LSA can uniquely identify an LSA. **(Right Answers)**
- B. The DD packet contains only the header information of the LSA. **(Right Answers)**
- C. DD packet contains LSA details
- D. LSA head is only a small part of the LSA **(Right Answers)**

Answer: ABD

713. As shown in the figure, the network administrator wants to manually aggregate the two physical links between SWA and SWB into one Eth-trunk link; which of the following description is correct?

- A. Cannot be aggregated **(Right Answers)**
- B. It works normally after aggregation
- C. It can be aggregated. Only GE ports can send and receive data after aggregation
- D. It can be aggregated. Only Ethernet ports can send and receive data after aggregation.

Answer: A

714. Which descriptions are correct about the Ethernet subinterface? (Multiple Choice)

- A. The subinterface cannot be configured with an IP address.
- B. A subinterface can be bound to multiple VLANs **(Right Answers)**
- C. The IP address of the sub-interface cannot belong to the same network segment. **(Right Answers)**
- D. The subinterface ID should be the same as the VLAN ID

Answer: BC

715. Ethernet frames are processed and forwarded in the form of VLAN TAGs inside the switch.

- A. True **(Right Answers)**
- B. False

Answer: A

716_ As shown in the following figure, from the security point of view, Router A refuses to receive OSPF packets, GE packets, IGMP packets from G0/0/1 Which of the following command can fulfill this requirement?

- A. acl number 3000 rule 5 deny rule 10 deny 89 rule 15 deny icmp # interface GigabitEthernet0/0/1 traffic-filter inbound acl 3000 #
- B. acl number 2000 rule 5 deny 47 rule 10 deny 89 rule 15 deny 1 # interface GigabitEthernet0/0/1 traffic-filter inbound acl 2000 # **(Right Answers)**
- C. acl number 3000 rule 5 deny 47 rule 10 deny 89 rule 15 deny 1 # interface GigabitEthernet0/0/1 traffic-filter inbound acl 3000 #
- D. acl number 3000 rule 5 deny rule 10 deny ospf rule 15 deny icmp # interface GigabitEthernet0/0/1 traffic-filter inbound acl 3000 #

Answer: B

117. What is the length of the Traffic Class field in the IPv6 packet header?

- A. 4
- B. 8 **(Right Answers)**
- C. 2
- D. 6

Answer: B

718. How many ways to generate a DHCP device unique identifier DUID?

- A. 3
- B. 2 **(Right Answers)**
- C. 4
- D. 1

Answer: B

719 Which of the following descriptions are correct about IPv6? (Multiple Choice)

- A. IPv6 address length is 128 bits. **(Right Answers)**
- B. ICMPv6 address length is 64 bits
- C. When an IPv6 packet has multiple extension headers, the extension header must appear in an orderly manner **(Right Answers)**
- D. When an IPv6 packet has multiple extension headers, the extension header can appear randomly

Answer: AC

720 The packet capture tool captures an Ethernet frame and finds that the value of the Type/Length field of the frame is 0x0800 Which of the following descriptions are correct about the frame? (Multiple Choice)

- A. The frame carries an IPX message.
- B. The frame carries an IP packet **(Right Answers)**
- C. The frame structure of the frame is the Ethernet II format **(Right Answers)**
- D. The frame structure of the frame is 802.3 format

Answer: BC

721 The MAC address table of a switch is as follows. If the switch receives a data frame with the destination MAC of 5489-985-18a8 from the Eth0/0/2 port, which of the following statements is correct?

- A. Forward this data frame from the Eth0/0/2 port
- B. Forward this data frame from the Eth0/0/1 port
- C. Discard this data frame **(Right Answers)**
- D. Flood this data frame out

Answer: C

722. The administrator plans to implement a route backup by configuring a static floating route. Which is the correct implementation method?
- A. The administrator needs to configure different protocol priority values for the primary static route and the alternate static route. (Right Answers)
 - B. The administrator needs to configure different metrics for the primary static route and the standby static route.
 - C. The administrator needs to configure different TAGs for the primary static route and the standby static route.
 - D. The administrator only needs to configure two static routes.

Answer: A

723. Regarding the main function of the router, which of the following statements are wrong? (Multiple Choice)
- A. Establish routing tables through multiple protocols
 - B. Guide data forwarding according to the routing table
 - C. Forward according to the source IP address of the received packet (Right Answers)
 - D. Realize communication between devices on the same network segment (Right Answers)

Answer: CD

724. The administrator finds that the file cannot be transferred to the Huawei AR200 router through TFTP. What is the possible cause?
- A. TCP port 69 of the TFTP server is disabled
 - B. The username on the TFTP server does not exist.
 - C. The username and password on the TFTP server have been modified.
 - D. UDP port 69 of the TFTP server is disabled (Right Answers)

Answer: D

725. As shown in the following figure, the switch configuration information is as follows. Which of the following statements are correct? (Multiple Choice)

- A. Host B and host C can ping each other (Right Answers)
- B. Host A and Host B cannot ping (Right Answers)
- C. Host A and Host C can ping each other (Right Answers)
- D. All hosts can ping each other

Answer: ABC

726. Which of the following descriptions are correct about the PPP? (Multiple Choice)

- A PPP supports bundling multiple physical links into logical links to increase bandwidth **(Right Answers)**
- B. PPP supports plaintext and ciphertext authentication (Right Answers)
- C. PPP is not scalable and cannot be deployed on an Ethernet link.
- D. For the physical layer, PPP supports asynchronous links and synchronous links. **(Right Answers)**
- E. PPP supports multiple network layer protocols such as 'PCP and IPXCP. **(Right Answers)**

Answer: ABDE

727. The PPPoE client sends a PADI message to the server, and the server replies with a PADO message. What frame is the PADO packet?

- A. Multicast
- B. Broadcast **(Right Answers)**
- C. Unicast
- D. Anycast

Answer: B

728. The following rules exist in an ACL of the router: rule deny tcp source 192.168.1.0 0.0.0.255 destination 172.16.10.1 0.0.0.0 destination-port eq 21

Which of the following statement is correct?

- A. The source IP address is 192.168.1.1, the destination IP address is 172.16.10.1, and all TCP packets with the destination port number 21 match this rule. **(Right Answers)**
- B. The source IP address is 192.168.1.1, the destination IP address is 172.16.10.2, and all TCP packets with the destination port number of 21 match this rule.
- C. The source IP address is 192.168.1.1, the destination IP address is 172.16.10.3, and all TCP packets with the destination port number 21 match this rule.
- D. The type of ACL is basic ACL.

Answer: A

729. Which of the following IPv6 extension headers can appear twice?

- A. Destination option extension header **(Right Answers)**
- B. Fragment extension header
- C. Upper layer protocol data message
- D. hop-by-hop option extension header

Answer: A

730. When the host uses the stateless address autoconfiguration scheme to obtain an IPv6 address, the DNS server address information cannot be obtained.

- A. True **(Right Answers)**
- B. False

Answer: A

731 Which of the following packets is sent by the DHCPv6 client before sending a request packet to the DHCPv6 server?

- P A RA
- B RS **(Right Answers)**
- C. NA
- D. NS

Answer: B

732. Which type does the IPv6 address FE80::2E0TCFF:FE6F:4F36 belong to?

- A. Multicast address
- B. Link-local address **(Right Answers)**
- C. Global unicast address
- D. Anycast address

Answer: B

733. In the DHCPv6 stateless automatic allocation scheme, the host does not need to send any DHCPv6 packets.

- A. True
- B. False **(Right Answers)**

Answer, B

734. The last option field of IPv4 is variable length optional information. What is the maximum Length of this field?

- A. 40B **(Right Answers)**
- B. 20B
- C. 60B
- D. 10B

Answer: A

735. Regarding the role of ARP protocol and packet encapsulation, which description is correct?

- A. The MAC address of the destination and the address of the UUID can be obtained through the ARP protocol.
- B. ARP protocol supports deployment on PPP links and HDLC links.
- C. ARP protocol is based on Ethernet encapsulation **(Right Answers)**
- D. Inverse ARP in ARP is used to resolve device names

Answer: C

736. The STP root switch is elected based on the priority of the switch. In RSTP, the switch priority and MAC address are compared at the same time.

- A. True
- B. False **(Right Answers)**

Answer: B

737. Which of the following statement is correct?

- A. The switch works at the network layer.
- B. The router works at the physical layer.
- C. The switch works at the physical layer
- D. The router works at the network layer. **(Right Answers)**

Answer:

738. A router learns routes to the same destination address through RIP, OSPF, and static routes. By default, VRP will ultimately choose which protocol to learn the route through?

- A. The routes learned by the three protocols are selected.
- B. Static routing
- C. OSPF (Right Answers)
- D. RIP

Answer: C

739. If the network administrator does not configure a backbone area, the router automatically creates a backbone area.

- A. True
- B. False (Right Answers)

Answer: B

740. What modes does device link aggregation support? (Multiple Choice)

- A. Mixed mode (Right Answers)
- B. Manual load sharing mode (Right Answers)
- C. Manual master mode
- D. LACP mode

Answer: AB

741. The output information of a sub-interface of a router aggregation port 1 is as follows. According to this information, which of the following statements are correct? (Multiple Choice)

- A. The sub-interface of the aggregation port carries the VLAN TAG 100 when forwarding the data frame.
- B. The IP address of the subinterface of the aggregation port is 10.0.12.2/24. (Right Answers)
- C. There are two links in the aggregation port. (Right Answers)
- D. The subinterface number of the aggregation port is 100. (Right Answers)

Answer: BCD

742. As shown in the figure, the RTA uses NAT technology and implements a many-to-many non-NAPT address translation by defining an address pool, so that hosts on the private network can access the public network. Assume that there are only two public IP addresses in the address pool, and the addresses have been assigned to hosts A and B. If host C also wants to access the public network, which of the following descriptions is correct?

- If RTA assigns the last public network address to host C, and host B is kicked off the line.
- B. All hosts can use the public network address in turn to access the public network.
- C. Host C cannot be assigned to the public network address and cannot access the public network. (Right Answers)
- D. RTA assigns the first public network address to host C, and host A is kicked off the line.

Answer: C

743. The OSPFv3 interface information of a router is as follows. Which of the following statements are correct? (Multiple Choice)

- A. The network type of this interface is P2P. (Right Answers)
- B. The Router-ID of this interface is 10.0.0.6. (Right Answers)
- C. The interface does not establish an adjacency relationship.
- D. The interface area number is 1 (Right Answers)

Answer: ABD

744. Which type of network does OSPFv3 need to elect DR?

- A. P2P network
- B. P2MP network
- C. CLNP Network
- D. Broadcast network **(Right Answers)**

Answer: D

745. Compared to IPv4, there is no IHL field in the IPv6 header.

- A. True (Right Answers)
- B. False

Answer: A

746. The output information of a router is as follows. Which of the following statements are correct? (Multiple Choice)

- A. OSPFv3 process number is 1. (Right Answers)
- B. The DR priority of this router is 1. (Right Answers)
- C. This router is BDR
- D. The router-ID of the neighboring router is 10.0.1.1. (Right Answers)

Answer: ABD

747 A company applying for a Class C IP address segment needs to be evenly distributed to 8 subsidiaries. The largest subsidiary has 14 computers. Different subsidiaries must be in different network segments. What should the subnet mask be set to?

- A 255 255 255 240
- B 255 255 255 192
- C 255 255 255 0
- D 255 255 255 128 (Right Answers)

Answer: D

748. Which of the following commands can be used to check the session status of a PPPoE client?

- A. display ip interface brief
- B. display pppoe-client session packet (Right Answers)
- C. display pppoe-client session summary
- D. display current-configuration

Answer: B

749. Which of the following configurations belong to Layer 2 ACL?

- A. rule 10 permit 12-protocol arp (Right Answers)
- B. rule 25 permit source 192.168.1.1 0.0.0.0
- C. rule 20 permit source-mac 0203-0405-0607
- D. rule 15 permit vlan-id 100

Answer: A

750. The MPLS label header is encapsulated between the data link layer header of the message and the network layer header.

- A. True (Right Answers)
- B. False

Answer: A